

PURINES, CREATINE, DEFECTIVE METHYLATION
AND THEIR BIOCHEMICAL AND CLINICAL
RELATIONSHIP

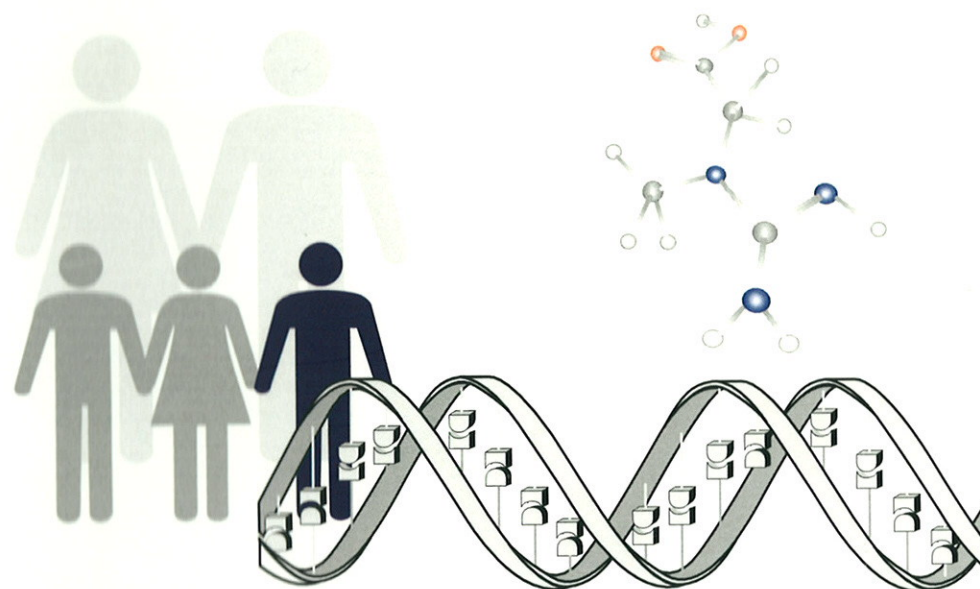

Helena Paula de Freitas Caldeira Araújo
2003

**PURINES, CREATINE, DEFECTIVE METHYLATION
AND THEIR BIOCHEMICAL AND CLINICAL
RELATIONSHIP**

Helena Paula de Freitas Caldeira Araújo

2003

Cover design: César Fernandes and Contrakapa

Idea: Helena Silva and César Fernandes

Printing: Grafimadeira

61
ARA Pwz
EX. 1
TJD

**Purines, Creatine, Defective Methylation and Their
Biochemical and Clinical Relationship**



**Purinas, Creatina, Metilação Deficiente e Sua
Interrelação Bioquímica e Clínica**



Dissertação apresentada à Universidade da Madeira para obtenção
do grau de Doutor em Bioquímica

Helena Paula de Freitas Caldeira Araújo

2003

Promotor: Dr. Marinus Duran

Copromotors: Prof. Dr. Isabel G. Tavares de Almeida
Prof. Dr. Helena P. Gaspar Tomás

The studies presented in this thesis were performed at the “Centro de Patogénese Molecular” (Prof. Dr. I. Tavares de Almeida), “Faculdade de Farmácia da Universidade de Lisboa”, Portugal, at the Department of Paediatrics and Clinical Chemistry (Dr. M. Duran), Academic Medical Centre, University of Amsterdam, The Netherlands and at the “Departamento de Química”, “Universidade da Madeira”, Funchal, Portugal.

Part of this work was financially supported by “Programa de Desenvolvimento Educativo para Portugal” (PRODEP)- “Formação Avançada no Ensino Superior”.

*Ao Francisco
À Inês e Leonor*

*Ao Meu pai
À minha mãe*

*Só é útil o conhecimento
que nos torna melhores.*

(Sócrates)

CONTENTS

Abbreviations.....	XV
Summary	XXI
Sumário.....	XXV
PART I – GENERAL INTRODUCTION.....	31
Chapter 1 – Aims of the Study.....	33
Chapter 2 - Introduction	37
1. Metabolic Functions of Nucleotides.....	39
2. Human Purine Metabolism.....	39
2.1 Purine Synthesis <i>de novo</i>	40
2.2 Purine Inter-conversions.....	42
2.3 Purine Catabolism.....	42
2.4 Purine Salvage	44
2.5 Regulation of Purine Biosynthesis	44
2.6 Regulation of Purine Inter-conversions	46
2.7 Regulation of Purine Degradation.....	46
3. Inherited Disorders of Purine Metabolism	46
3.1 Phosphoribosylpyrophosphate Synthetase (PRS) Superactivity	48
3.2 Hypoxanthine-Guanine Phosphoribosyltransferase (HPRT) Deficiency	50
3.3 Adenine Phosphoribosyltransferase (APRT) Deficiency.....	51
3.4 Adenosine Deaminase (ADA) Deficiency.....	53
3.5 Purine Nucleoside Phosphorylase (PNP) Deficiency.....	55

Contents

3.6 Muscle AMP Deaminase (AMPD) Deficiency	56
3.7 Xanthine Oxidase/Dehydrogenase (XO) Deficiency	60
3.8 Adenylosuccinate Lyase (ADSL) Deficiency	62
3.9 Deoxyguanosine Kinase (dGK) Deficiency	65
3.10 Renal Tubular Defects of Uric Acid Transport	66
3.11 Identification of Purine Metabolism Defects	67
4. One-Carbon Unit Metabolism.....	69
5. Homocysteine Metabolism and Regulation	70
5.1 Control of Homocysteine Metabolism.....	72
5.2 Disorders of Homocysteine Metabolism	72
5.2.1 Methionine Adenosyltransferase (MAT) Deficiency	72
5.2.2 Cystathionine β -synthase (CBS) Deficiency	73
6. Folic Acid in One-Carbon Metabolism	75
6.1 Metabolic Pathways and Enzymes.....	75
6.1.1 Hereditary Folate Malabsorption.....	79
6.1.2 Cellular Uptake Defects.....	79
6.1.3 Glutamate Formiminotransferase Deficiency	79
6.1.4 Methylenetetrahydrofolate Reductase (MTHFR) Deficiency	80
7. Cobalamin Metabolism	82
7.1 Absorption and Transport Defects	84
7.1.1 Intrinsic Factor (IF) Deficiency	84
7.1.2 Selective Vitamin B12 Malabsorption (Imerslund-Gräsbeck Syndrome)	85
7.1.3 Haptocorrin (R-Binder or Transcobalamin) Deficiency	85
7.1.4 Transcobalamin II (TC II) Deficiency.....	86
7.2 Disorders of Intracellular Cobalamin Metabolism.....	87
7.2.1 Functional Methionine Synthase Deficiency (Cobalamin E and G).....	87
7.2.2 Combined Deficiencies of Methylcobalamin and Adenosylcobalamin	88

8. Creatine Metabolism.....	90
8.1 Guanidinoacetate Methyltransferase (GAMT) Deficiency	92
8.2 Arginine:Glycine Amidinotransferase (AGAT) Deficiency	93
8.3 X-Linked Creatine Transporter Deficiency	94
9. Glycine Metabolism	94
9.1 Nonketotic Hyperglycinaemia (NKH)	95
10. Serine Metabolism.....	97
10.1 Disorders of Serine Biosynthesis	98
10.1.1 3-Phosphoglycerate Dehydrogenase Deficiency.....	98
10.1.2 3-Phosphoserine Phosphatase Deficiency	99
11. Sarcosine and Dimethylglycine Metabolism.....	99
11.1 Sarcosinaemia	99
11.2 Dimethylglycine Dehydrogenase (DMGDH) Deficiency.....	100
12. Analytical Chemical Aspects	101
References	106
PART II – PURINE AND PYRIMIDINE ANALYSIS AND REFERENCE VALUES.....	133
Chapter 3 – A New Solid-Phase Extraction Procedure for Purine and Pyrimidine Analysis	135
Chapter 4 – Uric Acid and Creatinine Levels in Two Groups of School Children.....	151
PART III – METABOLIC SCREENING OF PURINES AND CREATINE...163	
Chapter 5 – Urinary Uric Acid / Creatinine Ratio as a Screening Tool for Creatine Biosynthesis Defects.....	165

Contents

Chapter 6 – Guanidinoacetate Methyltransferase Deficiency Identified in Mentally Retarded Adults.....	179
Chapter 7 – Guanidinoacetic Acid is Decreased in Hyperornithinemia.....	199
PART IV - CONCLUSIONS	209
Chapter 8 – General Discussion and Future Prospects.....	211
Aknowledgements / Agradecimentos.....	223
<i>Curriculum Vitae</i>	<i>229</i>
List of Publications	231

ABBREVIATIONS

ADA	adenosine deaminase
AdoCbl	adenosylcobalamin
ADP	adenosine 5'-diphosphate
ADSL	adenylosuccinate lyase
AGAT	arginine:glycine amidinotransferase
AICAR	5'-phosphoribosyl-5-aminoimidazole-4-carboxamide
AIR	5'-phosphoribosyl-5-aminoimidazole
AMP	adenosine 5'-monophosphate
AMPD	muscle AMP deaminase deficiency
AO	aldehyde oxidase
APRT	adenine phosphoribosyltransferase
ATP	adenosine 5'-triphosphate
BHMT	betaine-homocysteine methyltransferase
cAMP	cyclic 3',5'-adenosine monophosphate
CBS	cystathionine β -synthase
CDP	cytidine 5'-diphosphate
cGTP	cyclic 3',5'-guanosine triphosphate
CID	combined immunodeficiency
CK	creatine kinase
CMP	cytidine 5'-monophosphate
¹³C NMR	carbon NMR
CoA	coenzyme A
CSF	cerebrospinal fluid
cSHMT	cytosolic SHMT
CTP	cytidine 5'-triphosphate
dCK	deoxycytidine kinase
dGK	deoxyguanosine kinase
2,8-DHA	2,8-dihydroxyadenine
DHF	dihydrofolate
DHPD	dihydropyrimidine dehydrogenase deficiency

Abbreviations

DMG	dimethylglycine
DMGDH	dimethylglycine dehydrogenase
DNA	deoxyribonucleic acid
2,3-DPG	2,3-diphosphoglycerate
dTMP	deoxythymidine 5'-monophosphate
dUMP	deoxyuridine 5'-monophosphate
EBV	Epstein-Barr virus
EDTA	ethylenediaminetetraacetic acid
EEG	electroencephalogram
EMG	electromyogram
FAD	flavin adenine dinucleotide (oxidised)
FGAM	5'-phosphoribosyl-N-formylglycineamide
FIGLU	formiminoglutamic acid
FJHN	familial juvenile hyperuricaemic nephropathy
GAA	guanidinoacetic acid
GAMT	guanidinoacetic acid methyltransferase
GAR	5'-phosphoribosyl-glycineamide
GC-MS	gas chromatography-mass spectrometry
GCS	glycine cleavage system
GDP	guanosine 5'-diphosphate
GFR	glomerular filtration rate
GMP	guanosine 5'-monophosphate
GSD	glycogen storage disease
GTP	guanosine 5'-triphosphate
8-HA	8-hydroxyadenine
HLA	human major histocompatibility complex
¹H NMR	proton NMR
HPLC	high performance liquid chromatography
H-protein	lipoic acid containing hydrogen carrier protein
HPRT	hypoxanthine-guanine phosphoribosyltransferase
IF	intrinsic factor
IgA	immunoglobulin A

IgG	immunoglobulin G
IgM	immunoglobulin M
IMP	inosine 5'-monophosphate
K_m	Michaelis constant
LC-MS	liquid chromatography-mass spectrometry
LND	Lesch-Nyhan disease
L-protein	lipoamide dehydrogenase
MAT	methionine adenosyltransferase
MCAD	medium-chain acyl-CoA dehydrogenase
MeCbl	methylcobalamin
MMA	methylmalonic acid
MRI	magnetic resonance imaging
MRS	magnetic resonance spectroscopy
mRNA	messenger RNA
MS	methionine synthase
mSHMT	mitochondrial SHMT
MS-MS	tandem mass spectrometry
mtDNA	mitochondrial DNA
MTHF	5-methyltetrahydrofolate
MTHFR	5,10-methylenetetrahydrofolate reductase
NAD⁺	nicotinamide adenine dinucleotide (oxidised)
NADH	nicotinamide adenine dinucleotide (reduced)
NADPH	nicotinamide adenine dinucleotide phosphate (reduced)
NK	natural killer
NKH	non ketotic hyperglycinaemia
NMDA	N-methyl-D-aspartate
NMR	nuclear magnetic resonance
PCR	polymerase chain reaction
PCr	phosphorylcreatine
PEG	polyethylene glycol
3-PGDH	3-phosphoglycerate dehydrogenase
PHAT	phosphohydroxypyruvate aminotransferase

Abbreviations

Pi	inorganic phosphate
PLP	pyridoxal 5'-phosphate
PNC	purine nucleotide cycle
PNP	purine nucleoside phosphorylase
PRPP	phosphoribosylpyrophosphate
PRS	phosphoribosylpyrophosphate synthetase
AmidoPRT	amidophosphoribosyltransferase
PSP	phosphoserine phosphatase
RBC	red blood cells
Rib-5-P	ribose 5'-phosphate
RNA	ribonucleic acid
SAH	S-adenosylhomocysteine
SAHH	SAH hydrolase
SAICA	5-aminoimidazole-4-N-succinocarboxamide
SAICAR	5'-phosphoribosyl-5-aminoimidazole-4-N-succinocarboxamide
SAM	S-adenosylmethionine
S-AMP	adenylosuccinic acid
SCID	severe combined immunodeficiency
SDH	sarcosine dehydrogenase
SHMT	serine hydroxymethyltransferase
SIM	selected ion monitoring
SO	sulphite oxidase
SPE	solid-phase extraction
TCI	transcobalamin I
TCII	transcobalamin II
THF	tetrahydrofolic acid
TLC	thin-layer chromatography
T-protein	tetrahydrofolate requiring enzyme
UDP	uridine 5'-diphosphate
UV	ultraviolet
XDH	xanthine oxidase/dehydrogenase

Abbreviations

XMP	xanthosine 5'-monophosphate
XO	xanthine oxidase/dehydrogenase

SUMMARY

The last few years have been characterized by an increasing recognition of new inherited metabolic disorders and additional patients, suggesting that many of these diseases are still underdiagnosed. Purine and pyrimidine inborn errors of metabolism cover a broad spectrum of disorders, most of them described in the last 30 years. Their high clinical heterogeneity is illustrated by the variable age of onset and affected systems which can vary from neurological to haematological, renal or immunological. On the other hand, creatine metabolism defects were described for the first time in 1994 and since then three defects have been identified. These are essentially characterized by speech disability and severe mental retardation. As selective screening programmes are of major importance for the study and treatment of inborn errors of metabolism, uric acid and creatinine are widely available, useful markers which allow to screen for both purine and creatine metabolism.

The studies presented in this thesis were planned as an attempt to increase knowledge in the underlying metabolic disorders of patients with severe mental handicaps. Evaluation of purine and pyrimidine metabolism was the primary objective of selective screening, as it would also allow to gain insight into one-carbon metabolism. Accordingly, this work is divided into four parts:

Part I comprises the objectives of the thesis (**chapter 1**) and the general introduction (**chapter 2**) which consists of a review of the literature concerning purine metabolism and associated disorders. Overall methylation metabolism and pathological features are also covered, as they are interrelated with both purine and creatine metabolism.

In **Part II**, the diagnostic scheme for screening was developed. A purine and pyrimidine reversed-phase liquid chromatography method with diode array detection was developed and validated, involving a prior purification step of urines by solid-phase extraction (**chapter 3**). The uric acid and creatinine in both plasma and urine, and the urinary uric acid to creatinine ratio were studied in a healthy population of school children and adolescents, so as to define normal control ranges for the population of

Summary

Madeira Island (**chapter 4**). 166 males and 167 females from pre-pubertal and pubertal age groups were investigated and the 95% confidence limits were calculated by age and sex. Mean plasma uric acid was found to increase with age in males (0.226 ± 0.010 to 0.332 ± 0.016) and females (0.226 ± 0.011 to 0.255 ± 0.011), as would be expected, and excretion did not present a significant increase both in males (3.28 ± 0.30 to 3.51 ± 0.31 mmol/L) and females (3.06 ± 0.32 to 3.47 ± 0.29 mmol/L), in contrast with what has been described in previous reports. Mean plasma and urine creatinine showed a significant increase with age in both gender and was higher in males from the pubertal group (plasma: 61.9 ± 1.3 to 78.4 ± 1.8 μ mol/L; urine: 7.86 ± 0.68 to 12.78 ± 1.13 mmol/L) than females (plasma: 61.0 ± 1.3 to 70.4 ± 1.4 μ mol/L; urine: 7.96 ± 0.74 to 11.27 ± 0.90 mmol/L). As to the mean ratios, they showed to decrease with age due to the increased clearance of creatinine. However, this decrease was more pronounced in males (0.429 ± 0.025 to 0.286 ± 0.018) than in females (0.389 ± 0.029 to 0.316 ± 0.092)

Part III concerns the study of 170 patients from an institution for the mentally retarded. Uric acid and creatinine were investigated in plasma as well as urine and the urinary uric acid to creatinine ratio was evaluated. Purine and pyrimidine metabolism was also investigated by HPLC analysis of plasmas and urines (**chapter 5**). No abnormalities of purine and pyrimidine metabolism were detected. Normal patterns of purine metabolism were even present in several patients with high urinary uric acid to creatinine ratios, combined with normal plasma uric acid levels, though. Taking the above results into consideration and considering that the uric acid to creatinine ratio allows evaluation of not only purine metabolism but also creatine metabolism, the excretion of guanidinoacetic acid (GAA), an intermediate of creatine biosynthesis, was investigated in several patients presenting urinary uric acid to creatinine ratios markedly above those of controls. GAA was analysed and quantified by stable isotope dilution gas chromatography / mass spectrometry. Increased levels of this intermediate were found in four patients (347 to 1624 mmol/mol creatinine; controls <150), indicating for guanidinoacetate methyltransferase (GAMT) deficiency, whereas the other investigated individuals presented normal

GAA excretion (below 100 mmol/mol creatinine). It was concluded that an increased urinary uric acid to creatinine ratio is a good indicator of GAMT deficiency and, therefore, the uric acid usefulness can be extended to creatine biosynthesis defects.

The clinical, biochemical and genetic features of the four patients with GAMT deficiency were investigated (**chapter 6**). Concentration of GAA was additionally investigated in the plasma, where abnormally high levels were observed (17.3 to 27.0 $\mu\text{mol/L}$; controls <3.3). In three of the patients from whom it was possible to obtain cerebrospinal fluid (CSF), GAA concentrations were remarkably similar (11.0, 11.3 and 12.4 $\mu\text{mol/L}$; controls <0.114). Measurement of GAMT activities was performed by analysis of the formed labelled creatine by gas-chromatography / mass spectrometry in cultured lymphoblasts from the 4 patients and the enzyme activity was undetectable (controls: 63-271 pmol/h mg protein). Mutational analysis of the GAMT gene was initially performed in genomic DNA isolated from blood samples of two affected sisters and family relatives (parents and brother). Homozygosity for a novel missense mutation in exon 1, a G to C transversion (c.59G>C) which results in the substitution of triptophan by serine at position 20 (W20S) was detected in both of these patients while the parents and brother were carriers. The same mutation was found in a third patient who belonged to the same pedigree.

DNA sequence analysis of the fourth patient revealed a different missense mutation. A G to A transition (c.506G>A) located in exon 5 resulting in the substitution of cysteine by tyrosine at position 169 (C169Y).

The common clinical features of these patients were the unremarkable newborn periods, the more or less normal development in the first months of life followed by developmental arrest or delay around the age of 1 year. Mental regression and lack of speech were also recurrent manifestations in all of them. However, the disease showed clinical heterogeneity since the same mutation gave origin to quite different phenotypes. As such, the two affected sisters differed from the other relative patient in that they had convulsions as one of the first symptoms, whereas he never displayed that symptom. On the other hand, the sisters never presented the behaviour disturbances which were detected in their relative.

Summary

Considering the involvement of GAMT in the methylation metabolism, it was postulated that its absence along with the fact that creatine biosynthesis is the greatest consumer of total labile methyl groups, through SAM to SAH conversion, would lead to a possible accumulation of SAM and decrease of SAH formation, with possible implications on other methylation reactions. Reduction of SAH would also imply a decrease in homocysteine levels. Actually, plasma homocysteine was measured in two of the patients and showed decreased levels. However, in spite of CSF SAM concentrations in the high normal range or slightly elevated, CSF SAH levels were not decreased suggesting other regulatory mechanisms.

Studies on the regulation of GAA synthesis by arginine:glycine amidinotransferase (AGAT) were achieved by measurement of the creatine intermediate in individuals affected by gyrate atrophy of the choroid and retina with hyperornithinaemia (**chapter 7**). The low GAA plasma and urine concentrations allowed us to conclude that the high ornithine levels inhibit AGAT catalysed transamination leading to formation of GAA.

Finally, **Part IV** comprehends a general discussion of the main results and conclusions of the studies described in this thesis (**chapter 8**), as well as some future research prospects which might contribute to a better understanding of underlying mechanisms of the pathogenesis of creatine biosynthesis defects and to better treatment strategies.

SUMÁRIO

Nos últimos anos tem-se verificado um reconhecimento crescente de novos défices em vias metabólicas diversas. Esses défices e a subsequente identificação de novos doentes sugerem que continua ainda por esclarecer e caracterizar uma gama vasta de patologias associadas a alterações hereditárias do metabolismo. Os erros hereditários do metabolismo das purinas e pirimidinas compreendem um largo espectro de patologias. A heterogeneidade clínica deste grupo de doenças é ilustrada não só pela variabilidade da idade em que se manifestam, mas também, pela dos sistemas que afectam, desde o sistema neurológico ao hematológico, passando pelo renal e imunológico. Os erros hereditários do metabolismo da creatina, descritos pela primeira vez em 1994, constituem um conjunto de doenças cujo fenótipo clínico é caracterizado essencialmente por debilidade mental profunda e atraso ou ausência da fala. Entre eles, já foram identificados e caracterizados três tipos distintos de défices que afectam a via metabólica da biossíntese da creatina e, conseqüentemente, a formação da creatinina.

Os programas de rastreio selectivo dos erros hereditários do metabolismo têm-se revelado como de grande importância na caracterização dos mesmos e posterior introdução das medidas terapêuticas adequadas. Tendo em consideração que marcadores bioquímicos diversos permitem orientar o rastreio selectivo com vista à efectivação do diagnóstico bioquímico específico, o ácido úrico e a creatinina, biomarcadores de fácil acessibilidade revelaram ser de grande utilidade no despiste das alterações do metabolismo das purinas e da creatina.

Os estudos apresentados na presente dissertação foram desenvolvidos com o objectivo de avaliar a presença de alteração metabólica, na origem de atrasos psicomotores profundos, numa população de doentes internados em Instituição para aquele fim. A avaliação do metabolismo das purinas e pirimidinas constituiu o principal objectivo do rastreio selectivo, uma vez que permitiria igualmente obter dados indicadores de possíveis alterações nas reacções metabólicas envolvidas na transferência de uma unidade de carbono, o grupo metilo, interveniente na biossíntese da creatina.

Sumário

O trabalho desenvolvido constituinte da presente dissertação, engloba quatro grandes secções, nomeadamente:

Parte I – objectivos do trabalho desenvolvido (**capítulo 1**) e introdução geral (**capítulo 2**).

Na introdução geral, à luz dos conhecimentos actuais, apresenta-se uma revisão exaustiva das vias metabólicas envolvidas na síntese e degradação das purinas e pirimidinas, assim como dos processos metabólicos interligados com a transferência de uma unidade de carbono, dada a interrelação dos mesmos, quer com o metabolismo das purinas, quer com o da creatina. As patologias associadas são referenciadas, dando-se particular relevo aos défices enzimáticos e biomarcadores que possibilitam a efectivação do respectivo diagnóstico bioquímico.

Parte II – desenvolvimento experimental e obtenção de valores de referência dos biomarcadores seleccionados, ácido úrico e creatinina. Engloba o desenvolvimento de um novo método para o isolamento das purinas e pirimidinas a partir de amostras biológicas, particularmente urina, usando a extracção em fase sólida, de forma a se obterem fracções tanto quanto possível ausentes de interferentes que co-eluem com os compostos de interesse, na posterior análise por cromatografia de alta resolução em fase reversa. Apresentam-se os dados referentes à validação do processo cromatográfico global, quer para soluções padrão, quer para amostras biológicas (**capítulo 3**).

Os biomarcadores, ácido úrico e creatinina, que constituíram a base do rastreio levado a cabo posteriormente numa população de doentes com atraso psicomotor, tinham sido previamente determinados numa população saudável de crianças e adolescentes em idade escolar. Este estudo foi planificado para se estabelecerem os valores de referência dos referidos biomarcadores, quer plasmáticos, quer urinários, assim como os da razão urinária ácido úrico / creatinina para a população da ilha da Madeira, nas faixas etárias estudadas (**capítulo 4**). Neste âmbito, investigaram-se 166 rapazes e 167 raparigas de dois grupos etários diferentes, um pré-pubertário e outro pubertário e calcularam-se os limites de confiança a 95%, em função da idade e do sexo. Verificou-se que o valor médio de ácido úrico plasmático aumentou com a idade, quer no sexo masculino (0.226 ± 0.010 a

0.332 ± 0.016), quer no feminino (0.226 ± 0.011 a 0.255 ± 0.011), tal como era de esperar. Quanto à excreção de ácido úrico, ao contrário do que tem sido descrito, não se verificou aumento significativo com a idade, em ambos os sexos (M: 3.28 ± 0.30 a 3.51 ± 0.31 mmol/L; F: 3.06 ± 0.32 a 3.47 ± 0.29 mmol/L). Os valores médios de creatinina plasmática e urinária aumentaram significativamente com a idade, em ambos os sexos. No entanto, este aumento foi mais marcante nos rapazes do grupo pubertário (plasma: 61.9 ± 1.3 a 78.4 ± 1.8 µmol/L; urina: 7.86 ± 0.68 a 12.78 ± 1.13 mmol/L) do que nas raparigas do mesmo grupo (plasma: 61.0 ± 1.3 a 70.4 ± 1.4 µmol/L; urina: 7.96 ± 0.74 a 11.27 ± 0.90 mmol/L). Por fim, as razões urinárias médias ácido úrico / creatinina apresentaram um decréscimo significativo com a idade, devido a um aumento da clearance da creatinina, tendo este decréscimo sido mais pronunciado nos rapazes (0.429 ± 0.025 a 0.286 ± 0.018) do que nas raparigas (0.389 ± 0.029 a 0.316 ± 0.092).

Parte III – avaliação metabólica de 170 indivíduos pertencentes a uma instituição de deficientes com atraso psicomotor.

Tendo em consideração os biomarcadores previamente seleccionados, determinaram-se os níveis de ácido úrico e de creatinina plasmáticos e urinários. Calculou-se a razão urinária ácido úrico / creatinina e este parâmetro foi analisado em função do teor plasmático de ácido úrico e creatinina. A análise cuidada dos resultados permitiu a selecção dos doentes com suspeita de serem portadores de alteração no metabolismo das purinas e pirimidinas ou no metabolismo da creatina (**capítulo 5**). Deste modo, todos os doentes que apresentaram aumento da razão ácido úrico / creatinina, independentemente do teor respectivo de creatinina plasmática, foram investigados no âmbito do metabolismo das purinas e pirimidinas. Obtiveram-se os perfis cromatográficos plasmáticos e urinários, após análise por HPLC, como descrito no capítulo 2. Não se detectaram anomalias nos perfis metabólicos das purinas e pirimidinas, o que permitiu excluir a presença de alteração daquelas vias metabólicas na origem das patologias associadas aos doentes estudados.

Nos doentes em que se constatou uma elevada razão urinária ácido úrico / creatinina concomitante com baixo teor de creatinina plasmática, investigou-se a possível presença de alteração na via da biosíntese da

Sumário

creatina, o precursor da creatinina, a qual tem sido igualmente associada com a presença de atraso psicomotor. A alteração mais comum na biosíntese da creatina é devida à falta de actividade da metiltransferase do ácido guanidinoacético (GAMT), levando à acumulação do ácido guanidinoacético (GAA), o precursor da creatina, nos fluidos biológicos. Deste modo, nos doentes seleccionados, determinou-se o teor de GAA urinário através da análise, após diluição isotópica, por cromatografia gasosa de alta resolução acoplada à detecção por espectrometria de massa em modo SIM. Detectaram-se níveis elevados (347 a 1624 mmol/mol creatinina; controlos <150) daquele metabolito em quatro dos doentes estudados. Os restantes indivíduos rastreados apresentaram uma excreção normal de GAA (< 100 mmol / mol creatinina). Sendo a presença de níveis urinários de GAA elevados, fortemente sugestiva de deficiente actividade da GAMT, demonstrou-se assim que a análise criteriosa da razão urinária ácido úrico / creatinina constitui um bom indicador para o rastreio dos défices da biosíntese da creatina, nomeadamente dos défices em GAMT.

A confirmação inequívoca da possível deficiência em GAMT nos doentes com elevada excreção de GAA foi efectuada através de estudos bioquímicos adicionais e de caracterização molecular. Paralelamente, efectuou-se o estudo familiar e analisaram-se exaustivamente as histórias clínicas respectivas. Os dados globais fazem parte do **capítulo 6**. A concentração plasmática e do líquido cefalo-raquidiano (LCR), em GAA, foram avaliadas tendo-se encontrado valores anormalmente elevados em ambos os fluidos biológicos (Plasma: 17.3 a 27.0 $\mu\text{mol/L}$; controlos <3.3; LCR: 11.0 a 12.4 $\mu\text{mol/L}$; controlos <0.114). É de salientar que não se detectou a variabilidade verificada nos teores urinários e plasmáticos de GAA, entre os doentes estudados, em relação aos respectivos LCR. A actividade enzimática da GAMT foi avaliada em culturas de linfoblastos obtidas a partir de colheitas de sangue dos doentes em estudo, através da determinação do teor de creatina formada a partir do substrato apropriado. A análise da creatina marcada foi efectuada por cromatografia gasosa acoplada à espectrometria de massa. As actividades enzimáticas encontradas foram nulas (controlos: 63-271 pmol/h mg proteína), o que confirmou a ausência de funcionalidade do enzima GAMT. A análise mutacional do gene GAMT,

nos casos index e familiares foi, sempre que possível, efectuada em ADN genómico isolado a partir de amostras de sangue periférico. Em três dos doentes pertencentes a uma mesma família, duas irmãs e um primo, detectou-se uma nova mutação no exão 1, em ambos os alelos, correspondente a uma transversão de G para C (c.59G>C) resultando na substituição do triptofano pela serina na posição 20 (W20S). Os pais e irmão das duas irmãs doentes mostraram ser portadores da mutação W20S.

O outro caso index revelou ser portador, em homozigotia, de uma mutação diferente da detectada nos casos acima referidos, após análise sequencial do ADN. Esta mutação, corresponde a uma transição de G para A (c.506G>A), localizada no exão 5 e que resulta na substituição da cisteína pela tirosina na posição 169 (C169Y).

Tal como em todos os outros casos descritos na literatura, os principais sintomas – atraso psicomotor e ausência de fala – que têm sido associados à deficiência em GAMT, foram igualmente detectados nos casos index agora descritos. A análise detalhada das histórias clínicas respectivas dos doentes portadores do mesmo genótipo revelou alguma heterogeneidade fenotípica, devido à presença de convulsões, como primeira manifestação, nas duas irmãs doentes e de hiperactividade no outro doente da mesma família.

Tendo em consideração que a reacção catalizada pela GAMT, que leva à formação de creatina, consome cerca de 90% dos grupos metilo disponíveis e que estes são fornecidos na conversão de S-adenosilmetionina (SAM) em S-adenosil-homocisteína (SAH), foi colocada a hipótese de se verificar uma eventual acumulação de SAM e decréscimo de SAH, com possíveis implicações em outras reacções de metilação, na presença de défices de GAMT. Assim sendo, seria igualmente de esperar que uma redução dos níveis de SAH se reflectisse numa diminuição do teor de homocisteína, um produto da sua hidrólise. Com efeito, a homocisteína plasmática foi avaliada em dois dos doentes, nos quais foram detectados níveis significativamente inferiores (2 e 3 μM) ao normal ($> 7 \mu\text{M}$). No entanto, apesar de no LCR os níveis de SAM se encontrarem no limite superior do valor de referência, ou mesmo ligeiramente elevados, os de SAH não se apresentaram diminuídos, sugerindo a possível existência de outros mecanismos reguladores.

Sumário

A fim de se avaliar o efeito da presença de níveis elevados de ornitina na regulação da actividade do enzima arginina:glicina amidinotransferase (AGAT), o qual intervém na síntese do par ornitina:GAA a partir do par arginina:glicina, avaliou-se o teor plasmático e urinário de GAA em quatro doentes com hiperornitinémia causada por deficiente actividade do enzima ornitina aminotransferase (**capítulo 7**). Detectaram-se teores de GAA muito baixos, em ambos os fluidos biológicos, o que permitiu concluir que a actividade do enzima AGAT é regulada pelo produto da reacção, face à inibição da mesma na presença de excesso de ornitina.

Parte IV – discussão geral e perspectivas futuras.

Os principais resultados e conclusões, respeitantes aos estudos descritos ao longo deste trabalho (**capítulo 8**), são aqui desenvolvidos. Para finalizar, são discutidas algumas perspectivas para futura investigação, no sentido de contribuir para o esclarecimento de alguns dos mecanismos subjacentes à patogénese dos defeitos da biosíntese da creatina e aumento da eficácia de novas estratégias terapêuticas.



PART I

GENERAL INTRODUCTION



CHAPTER

1

AIMS OF THE STUDY

AIMS OF THE STUDY

Inborn errors of metabolism represent an enlarging spectrum of disorders, most of them recognised just recently. Many generate life-threatening illness early in life and a great part is associated with mental retardation and neurological abnormalities. The non-specific character of clinical signs and symptoms of most inherited metabolic diseases, allied to the major concern of early diagnosis to avoid further pathological consequences, makes early detection and detailed knowledge of each disorder of great relevance.

Patients with inherited disorders of metabolism often remain undiagnosed in institutions where most of the times metabolic screening has never been carried out. Actually, no such screening has ever been done in our community. The aim of this study was the biochemical genetic work-up of patients with a severe mental handicap. A possible contribution to the genetic mapping of Madeira Island population, a relatively small community with a high degree of consanguinity and a still limited knowledge about inborn errors of metabolism has also motivated the present work.

Studies of a large number of patients imply selective screening of inborn errors of metabolism which was, in this case, initially directed towards purine and pyrimidine metabolism.

A HPLC method for purine and pyrimidine analysis was initially developed with a new purification step of urines through solid-phase extraction, faster and simpler than the existing ones, to minimize interference of drug and diet components and to allow concentration of low level purine and pyrimidine metabolites.

Plasma and urine levels of uric acid and creatinine are usually evaluated prior to purine and pyrimidine analysis. Uric acid as the end-product of purine catabolic pathway is a useful diagnostic marker. Its concentration is easily analysed by routine clinical chemistry methods. The reason for evaluating creatinine is the frequent expression of all urine metabolites in relation to this parameter, obviating the necessity of 24-hour urines which are frequently difficult to obtain. Furthermore, creatinine is a convenient indicator of creatine stores and reflects the creatine biosynthesis. The

Chapter 1

urinary uric acid to creatinine ratio is a good screening test for purine disorders.

This has led us to design the study of uric acid and creatinine, in plasma and urine, from a large healthy population of school children and adolescents. This study allowed us to estimate our own community's reference intervals. Subsequently, both parameters were investigated in a large number of mentally retarded patients from an institute and it permitted to evaluate both purine and creatine metabolisms. Purine and pyrimidine analysis was carried out in plasmas and urines of all patients in the institution and additionally, in every healthy individual who showed to be at risk due to high or low uric acid production.

The metabolic screening in that first part of the study enabled us to identify several patients with GAMT deficiency. The very small number of reported patients and the limited state of knowledge of the disease, allowed us to undertake a broader study of GAMT and its implications in homocysteine metabolism, SAM, SAH and related metabolites. Hyperornithinaemia patients could also be good models for studying some biochemical changes. The promotion of a better understanding of clinical and biochemical changes of GAMT deficiency and consequently more specific treatment, became naturally one of the major objectives in these studies.

INTRODUCTION

**Purines and one carbon group metabolism, related pathways and
enzyme defects**

1. METABOLIC FUNCTIONS OF NUCLEOTIDES

Purine and pyrimidine nucleotides participate in many critical cellular functions ranging from precursors of RNA and DNA to second messengers. In fact, purine and pyrimidine deoxyribonucleosides, linked through phosphodiester bridges, form the backbone of the human genome and, on the other hand, as ribomononucleotides they play a vital role in energy metabolism as can be seen from ATP and GTP which constitute vital energy sources. ATP functions as a universal currency of energy in biological systems. Actually, it is not only involved in muscle contraction, active transport and maintenance of ion gradients but also serves as a phosphate donor for generation of other nucleoside triphosphates [1-5].

Nucleotide derivatives are activated intermediates in many reactions. To illustrate, UDP-glucose is a key intermediate in synthesis of glycogen and glycoproteins and GDP-mannose, GDP-fucose, UDP-galactose and CMP-sialic acid are all key intermediates in the synthesis of glycoproteins. CTP, CDP-choline, CDP-ethanolamine and CDP-diacylglycerols are involved in phospholipid metabolism. Furthermore, S-adenosylmethionine (SAM) is the major methyl donor for most cellular methylation processes involving methylation of RNA and DNA, sugars, phospholipids (formation of phosphatidylcholine from phosphatidylethanolamine) and formation of carnitine from lysine [1,3]. On the other hand, adenine nucleotides are components of three major coenzymes: nicotinamide adenine dinucleotide (NAD^+), flavin adenine dinucleotide (FAD) and coenzyme A. In addition, nucleotides serve as physiological mediators of several metabolic processes as can be seen from cAMP and cGTP acting as second messengers, from GTP being required for mRNA capping and signal transduction and from ADP being involved in the process of blood coagulation [1,3].

2. HUMAN PURINE METABOLISM

Overall body pools of purine compounds are provided by the diet and endogenous synthesis from nonpurine precursors. The human purine

metabolism involves two pathways leading to purine ribonucleotide synthesis: one is the biosynthesis *de novo*, an energetically expensive metabolic pathway, consisting of an endogenous synthesis of purine nucleotides from non-purine precursors [6]; the other is the purine *salvage* pathway by which purine bases and nucleosides can be re-synthesised to ribonucleotides. The latter is energetically less expensive and exerts feedback control on the former, restricting *de novo* purine synthesis to the minimum required to replace purine lost in the form of uric acid [5]. The nucleoside and base salvage and the nucleotide interconversions constitute a complex network of reactions that ensure efficient reutilisation of preformed purines [3,5]. In general, cellular purines are obtained through three different processes: *de novo* synthesis from smaller molecules, *salvage* of preformed bases and uptake from the extracellular environment.

2.1 Purine Synthesis *de novo*

The purine ring is formed *de novo* from several precursors: glycine, aspartate, glutamine, tetrahydrofolate and CO₂, which constitute small molecule donors for sequential construction on a ribose 5-phosphate (Rib-5-P) structure provided by phosphoribosylpyrophosphate (PRPP). This pathway involves 11 enzymatic reactions which lead to inosine monophosphate (IMP) as can be seen in Figure 1 [5,7].

The first reaction is the formation of PRPP, a key regulatory intermediate from d-Ribose-5-phosphate and MgATP by the action of phosphoribosylpyrophosphate synthetase (PRS) [8,9]. Then, PRPP condenses irreversibly with L-glutamine to give 5-phosphoribosyl-1-amine, constituting the first committed step of purine biosynthesis which is catalysed by amidophosphoribosyltransferase (AmidoPRT) [10].

The subsequent reactions leading to formation of the purine ring are summarized in Figure 1.

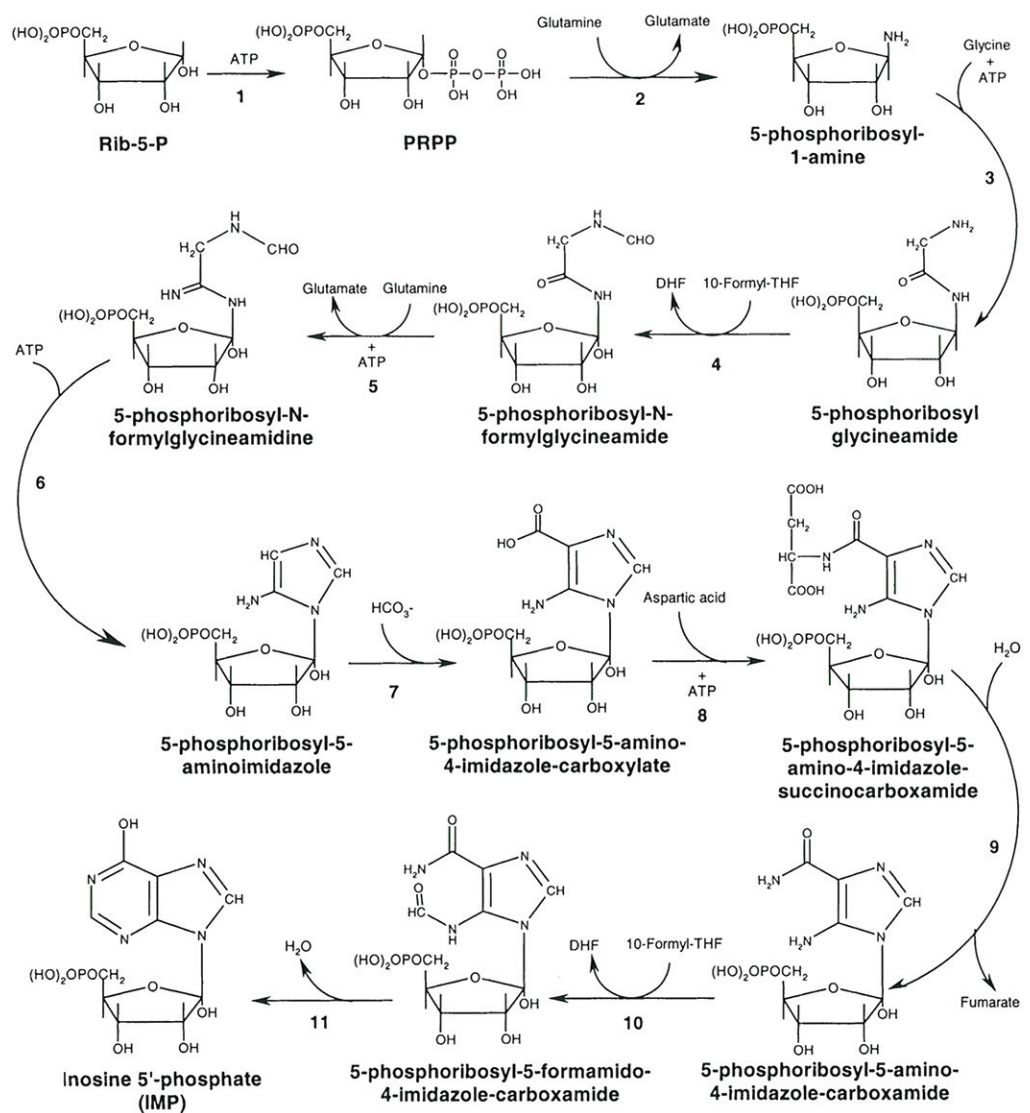

Figure 1 – Biosynthesis of IMP.

The enzymes catalysing the reactions are: 1. PRPP synthetase; 2. AmidoPRT; 3. GAR synthetase; 4. GAR transformylase; 5. FGAM synthetase; 6. AIR synthetase; 7. AIR carboxylase; 8. SAICAR synthetase; 9. Adenylosuccinate lyase; 10. AICAR transformylase; 11. IMP cyclohydrolase.

2.2 Purine Inter-conversions

All purine compounds are then derived from IMP (Figure 2), the central point for alternative biosynthetic pathways. It leads either to the production of adenosine 5'-monophosphate (AMP) and guanosine 5'-monophosphate (GMP), the major purine ribonucleotides involved in RNA and DNA synthesis, or to the purine catabolic pathway coming up to the irreversible formation of uric acid [5,7].

AMP, the precursor of ADP and ATP, derives from IMP by way of adenylosuccinic acid (S-AMP). This two-step reaction that requires GTP as the energy source for substitution of an amino group for the carbonyl group at carbon 6, is catalysed by adenylosuccinate synthetase [11]. GMP, the precursor of GDP and GTP, is formed through the intermediate xanthosine 5'-monophosphate (XMP), a reaction catalysed by IMP dehydrogenase where ATP provides the energy for transfer of the amido group of glutamine to carbon 2 of XMP. Thus, each of these nucleotide interconversion pathways depends on the availability of the product of the other [5,7].

Deamination of AMP to IMP is an additional interconversion reaction catalysed by AMP deaminase. This reaction liberates ammonia and belongs to the purine nucleotide cycle, which is particularly active in the muscle.

As a result, the net effect of all these reactions is the interconversion of adenine and guanine nucleotides in order to meet cellular needs [5].

2.3 Purine Catabolism

The purine catabolic pathway leads to the formation of uric acid under circumstances of nucleoside excess. Mononucleotides such as AMP, IMP, XMP and GMP are converted into their corresponding ribonucleosides by nonspecific phosphatases and by specific purine 5'-nucleotidases [12]. Then the purine nucleosides inosine, guanosine, their respective deoxy-nucleosides and xanthosine, in a smaller extent, though, are further catabolised by purine nucleoside phosphorylases (PNPs), to the respective purine bases hypoxanthine, guanine and xanthine [13]. These last reactions

are reversible and favour nucleoside synthesis under normal conditions. Subsequently, guanine is converted into xanthine by guanine deaminase, while adenosine derived from both AMP and S-adenosylhomocysteine metabolism, either proceeds through the deamination reaction of AMP to IMP, as it has been referred to before, or is transformed into inosine (and deoxyadenosine into deoxyinosine) by adenosine deaminase (ADA) [5,7].

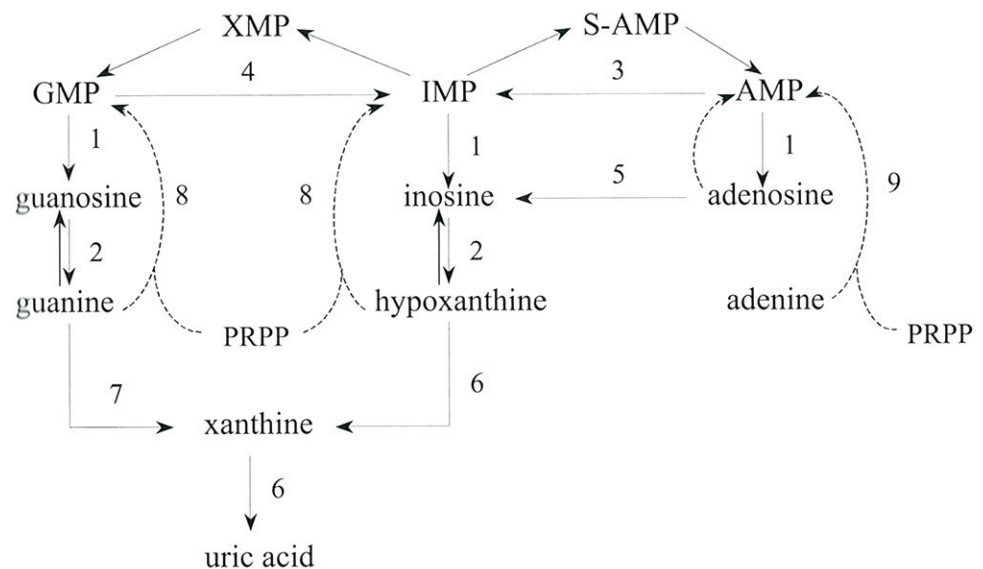

Figure 2- Purine inter-conversions and catabolism. Adapted from [2].

The enzymes catalysing catabolism are: 1. 5'Nucleotidase; 2. Purine nucleoside phosphorylase; 3. AMP deaminase; 4. GMP reductase; 5. Adenosine deaminase; 6. Xanthine oxidase; 7. Guanine deaminase. Dotted lines represent the salvage pathway and enzymes involved are: 8. Hypoxanthine-guanine phosphoribosyltransferase and 9. Adenine phosphoribosyltransferase.

Finally, both oxidation steps of conversion of hypoxanthine into xanthine and xanthine to uric acid are catalysed by xanthine oxidase (XO/XDH), a flavoprotein that exists in oxidase and dehydrogenase forms, being the

oxidase form responsible for the formation of uric acid as the final product of human purine metabolism (Figure 2) [5].

2.4 Purine Salvage

Free purine bases are formed by the hydrolytic degradation of endogenous or exogenous nucleotides and can be *salvaged* in two distinct ways. In fact, purine nucleotides can be synthesised from these preformed bases in a single step with transfer of PRPP to any of the purines by the action of phosphoribosyltransferases, resulting in the corresponding ribonucleotide [14,15]. Hypoxanthine-guanine phosphoribosyltransferase (HPRT) converts hypoxanthine and guanine into IMP and GMP respectively, and adenine phosphoribosyltransferase (APRT) converts adenine into AMP. These enzymes also accept several purine analogues as substrates [14-16].

The other salvage mechanism is a two-step pathway where purine nucleoside phosphorylases catalyse the reversible reaction of nucleoside formation from the corresponding base and ribose-1-phosphate [13]. Such nucleosides may then be re-phosphorylated by purine kinases giving nucleotides [17,18].

The great advantage of this pathway is that it is far more efficient than *de novo* synthesis in terms of energy consuming.

2.5 Regulation of Purine Biosynthesis

Production of purine nucleotides is determined by cellular requirements and is regulated by the *de novo* and *salvage* reactions. Overall control of purine synthesis *de novo* is maintained by the two initial enzymes of the biosynthetic pathway, PRS and AmidoPRT by exerting fine and broad control over changes in the availability of purine nucleotides. Fine control is ensured by alterations in the subunit structure and activity of AmidoPRT in response to small changes in purine concentrations, while broad control is maintained by the addition of changes in PRS activity in response to larger

variations of nucleotide concentrations [5,9]. PRS activity is less sensitive to purine nucleotide inhibition than AmidoPRT and it is also inhibited by pyrimidine and pyridine nucleotides (which also require PRPP to their synthesis) [5,19-24].

AmidoPRT is an allosteric enzyme which requires PRPP as a substrate. PRPP binds to the enzyme inducing a conformation change favouring activation and purine nucleotides competitively inhibit AmidoPRT by binding at distinct sites from substrate binding sites [19]. The monophosphates are more effective inhibitors than diphosphates and these, in turn, are more effective than triphosphates. Eventually, there is some synergism between nucleotides bearing different substituents (amino and hydroxy) at position 6 of the purine ring although this synergistic inhibition can be overcome by high concentrations of PRPP [5]. In most experimental conditions, increased intracellular PRPP concentrations have shown to accelerate purine synthesis *de novo* and depletion of this compound to slow the rate [8]. AmidoPRT exists in two different forms, a small (active) form which is reversibly converted into the large (inactive) form by nucleotides, this effect being blocked by increasing concentrations of PRPP [19,24].

PRS is an allosteric enzyme that catalyses synthesis of PRPP from MgATP and D-Ribose-5-phosphate in a reaction requiring P_i and free Mg^{2+} . The regulation of PRS activity is complex with at least three regulatory sites defined by ADP competitive inhibition as regards MgATP, competitive inhibition by 2,3-diphosphoglycerate (2,3-DPG) as regards Rib-5-P and noncompetitive inhibition of both substrates by many purine, pyrimidine and pyridine nucleotides, specially nucleoside diphosphates and triphosphates [5,21,22].

PRPP, the product of this reaction, is clearly a very important regulatory intermediate and since its availability controls the first committed step of purine biosynthesis, regulation of the PRS enzyme is an important determiner of overall purine synthesis. The availability of PRPP depends on the rate of synthesis by PRS, subsequent interaction with the AmidoPRT enzyme and its use in the salvage pathway [5,9].

2.6 Regulation of Purine Inter-conversions

Purine nucleotide inter-conversion reactions depend on end-product inhibition, directed at the first reaction, inhibiting the corresponding enzyme. It follows that AMP and GDP inhibit AMP-S synthetase and GMP inhibits IMP dehydrogenase. In these inter-conversion reactions of IMP to AMP or of IMP to GMP, GTP and ATP respectively, are required as energy donors. This fact implies a cross-regulation in which a nucleotide controls the synthesis of the other. Similarly, there is a direct product inhibition of the biosynthesis in each individual class [5,7].

2.7 Regulation of Purine Degradation

Ribonucleotide degradation is regulated in a rather complex manner. It is critically controlled by AMP deaminase and 5'-nucleotidases. AMP deaminase is an allosteric enzyme, which is activated by ATP and ADP and is inhibited by GTP and P_i . In circumstances requiring rapid ATP phosphorylation of substrates, release of inhibition of the enzyme results in the acceleration of nucleotide degradation to uric acid. Although interactions of these enzymatic activities are not entirely understood, it appears that ATP, ADP and P_i are key modulators of nucleotide catabolism [5,7].

3. INHERITED DISORDERS OF PURINE METABOLISM

The crucial role of purine nucleotides in the control of diverse cellular functions has also been demonstrated by the studies of the different inherited disorders, which have contributed to extend knowledge on these mechanisms. Defects in one or more enzymes of the metabolic pathways overviewed above, that lead to a loss of regulation of the normal recycling of these compounds and of the feedback control of their biosynthesis, are frequently associated with severe and often fatal disease.

The first purine disorder was reported in 1954 [25] although much earlier gout had been regarded as an inborn error of metabolism by A. E. Garrod [5]. Since then, around two tenths of enzyme defects have been recognised. Some are considered to be relatively benign, though. Those defects with defined clinical consequences are presented in Table 1.

Table 1. Purine metabolism disorders with clinical consequences in humans

Disorder	Abbreviation	McKusick	Year of first description
Adenosine deaminase	ADA	102700	1972
Adenylosuccinate lyase	ADSL	103050	1984
Adenine phosphoribosyltransferase	APRT	102600	1968
Familial juvenile hyperuricaemic nephropathy	FJHN	162000	1967
Hypoxanthine-guanine phosphoribosyltransferase	HPRT	308000	1964
Myoadenilate deaminase	AMPD1	102770	1978
Purine nucleoside phosphorylase	PNP	164050	1975
Phosphoribosylpyrophosphate synthetase	PRPS	311850	1972
Xanthine oxidase/dehydrogenase	XDH	278300	1954
Combined XDH/SO/AO	XDH/SO/AO	252150	1978
Combined XDH/AO	XDH/AO	603592	1990
Deoxyguanosine kinase	dGK	601465	2001

Adapted from [26] and [28].

Prior to 1950, gout represented a clinical problem, in spite of being a disorder in which the biochemical basis was perfectly elucidated. However, there was no effective treatment. In the past 50 years, the elucidation of purine biochemistry, the development of standard methods to measure uric acid, the discovery of several inherited enzyme defects leading to uric acid overproduction and the development of therapies to reduce serum urate concentration, have constituted major advances in controlling gout. Despite this, the metabolic basis of gout and of Familial Juvenile Hyperuricaemic Nephropathy (FJHN), a recently recognised form of dominant familial gout,

Chapter 2

affecting young people and children, all remain unclear [5,26,27]. The other purine defects recognised until now are inherited in an autosomal recessive manner or as X-linked recessive conditions [26].

At any rate, knowledge of the regulation of purine metabolic pathways was gained, in the last decades, mainly through the study of inborn enzyme defects [5,7]. The recognition of purine disorders can be very hard, since they are clinically and genetically very heterogeneous due to the different systems that can be affected, renal, immunological, neurological, haematological and musculo-skeletal [26,28]. Patients suffering from a defect in purine metabolism can present symptoms like acute or chronic renal disease, kidney stones, unexplained anaemia, immunodeficiency syndromes, mental retardation, epilepsy, autistic behaviour, self-mutilation and inability to talk or walk. The fact that this broad spectrum of symptoms can appear at any age and their recent recognition makes diagnosis extremely difficult [26].

Only the enzyme defects with defined clinical consequences will be reviewed here.

3.1 Phosphoribosylpyrophosphate Synthetase (PRS) Superactivity

PRPP is a substrate in the synthesis of purine and pyrimidine nucleotides and an allosteric regulator, as overviewed above. The formation of PRPP from ATP and Ribose-5-P is catalysed by a family of PRPP synthetase isoforms as already seen [9,22].

PRS superactivity is an X chromosome-linked purine metabolic defect, characterized by gout and uric acid overproduction, resulting from accelerated synthesis of PRPP and purine nucleotides [23]. It was first described by Sperling et al. [29] in brothers with early adult onset uric acid urolithiasis and gout associated with severe hyperuricaemia and hyperuricosuria. In this case, a variant form of PRS with a defect in allosteric regulation of enzyme activity by purine nucleotide inhibitors was accompanied by an accelerated synthesis of PRPP and purine nucleotide overproduction [30].

About 30 families with PRS superactivity have been reported with uric acid overproduction and heterogeneous kinetic mechanisms leading to excessive enzyme activity. These include (a) defective regulation of PRS with impaired responsiveness to allosteric effectors of its activity; (b) catalytic over-activity due to overabundance of the normal PRS1 isoform; (c) combined regulatory and catalytic defects and (d) increased affinity for Ribose-5-P. Catalytic superactivity is the most common aberration. All these enzyme abnormalities lead to a common consequence, which is purine nucleotide and uric acid overproduction, due to increased PRPP availability. The last, in turn, activates AmidoPRT accelerating purine synthesis de novo [5,31-33].

The disease is expressed in two clinical phenotypes. The most severe is characterized by affected hemizygous males showing early childhood symptoms of uric acid overproduction associated with neurodevelopmental impairment and sensorineural deafness [5,33]. Heterozygous female carriers in these families may develop gout during the reproductive period [5].

Studies of cultured cells from patients with these features have shown regulatory or combined defects in the enzyme. The least severe phenotype, with late juvenile-onset PRS superactivity, shows gout and uric acid urolithiasis but no neurological deficits. Overabundance of the normal PRS1 isoform is associated with this form [33].

The genetic basis of PRS superactivity has been identified but the mechanisms leading to metabolic and neurological derangements remain unclear [5,32].

Molecular studies have identified two X chromosomal loci encoding PRS1 and PRS2 cDNAs and tissue-specific differences in the expression of PRS1 and PRS2 transcripts. Point mutations in the PRPS1 gene were shown to result in altered allosteric control of PRS activity which has established the genetic basis for this defect [32]. In contrast, PRS catalytic superactivity reflects altered regulation of the expression of the normal PRS1 isoform possibly due to a pretranslational mechanism [34].

3.2 Hypoxanthine-Guanine Phosphoribosyltransferase (HPRT) Deficiency

Inherited deficiency of the purine salvage enzyme HPRT is an X-linked condition and can present as three clinical variants depending on the residual enzyme activity [35,36]. The Lesch-Nyhan variant, the most common and severe form of the disease, with less than 1.5% residual enzyme activity, was first described in 1964 [37] and the respective enzymatic defect was identified in 1967 [38]. Patients with this variant present severe delay in motor development, self-injurious behaviour, dystonic movement disorder, varying degrees of cognitive disability and an overproduction of uric acid. Hyperuricaemia is usually but not always present but the excretion levels of uric acid are always elevated unless renal failure exists [39]. In untreated patients this increase of production and excretion of uric acid often leads to nephrolithiasis [35].

These patients generally have unremarkable newborn periods and developmental delay only becomes evident around 3 to 9 months when the infant also shows hypotonia [35,40]. Further delay of motor development with pyramidal (spasticity and hyperreflexia) and extrapyramidal (dystonia and chorea) signs appear within the first year of age. Self-injurious behaviour, a hallmark feature of this disease, is observed in the majority of cases around the second and third year of life although it may occur from 6 months to 18 years [35,36]. The degree of motor developmental delay in these patients is such that they are often confined to a wheelchair [36]. Dysarthria and choreoathetosis are disabling symptoms which make communication very difficult for these patients. In general, they are moderate to severely retarded with IQ values ranging from 50 to 105 [35]. Megaloblastic anaemia was described in some patients although its origin has not been found. Serum folate, vitamin B12 and thyroid function were normal in these cases and the effectiveness of adenine supplements in reversing the anaemia suggested that purine limitation could be the underlying cause [41].

Patients exhibiting between 1.5 and 8% of residual enzymatic activity, the neurological variants, demonstrate uric acid overproduction with mild to moderate neurological disability but no behavioural abnormalities [35,36].

In the partial variants of HPRT deficiency, activity varies from 0 to 50% in erythrocyte assays. Patients are neurologically normal and demonstrate the consequences of a marked overproduction of uric acid such as nephrolithiasis and gout [36].

Although HPRT deficiency is inherited as an X-linked recessive condition it has been described in a few females due to additional genetic alteration [39,42]. The HPRT gene is on the long arm of X chromosome at q2.6 to 2.7. Its structure has been elucidated by cloning and sequencing [43] and more than 270 mutations have been identified until now [35,44].

The absence of HPRT, the enzyme that normally catalyses the conversion of hypoxanthine and guanine into their respective nucleotides: IMP and GMP, results in the accumulation of its substrates. As there is no other pathway for incorporating hypoxanthine and guanine into utilisable purines, they are eventually degraded to uric acid or excreted. Concentrations of xanthine and hypoxanthine are elevated in the blood and urine of patients with LND reflecting incomplete metabolism of these purines to uric acid [45].

Several studies have shown that HPRT deficiency is associated with an activation of purine synthesis de novo by the increased availability of PRPP, a substrate of the rate-limiting step and by the decrease of intracellular purine nucleotides which provokes lack of feedback control inhibition of purine synthesis. This combination of an increase of synthesis and decrease of recycling is responsible for the huge production of uric acid [39,45].

3.3 Adenine Phosphoribosyltransferase (APRT) Deficiency

The purine salvage enzyme APRT catalyses the synthesis of AMP from adenine and PRPP. Deficiency in this enzyme is inherited as an autosomal recessive trait and results in the inability to salvage free adenine provided by food and by the polyamine pathway which is actually, the main source of endogenous adenine in humans. Adenine, which is accumulated due to

Chapter 2

APRT deficiency, is oxidized via 8-hydroxyadenine (8-HA) to 2,8-dihydroxyadenine (2,8-DHA) by xanthine dehydrogenase. 2,8-DHA is an extremely insoluble compound, hence the main clinical manifestation of the disease is 2,8-DHA urolithiasis which can lead to serious complications [46,47,48].

Two types of APRT deficiency have been described. Type I with very low or undetectable enzyme activity in erythrocyte lysates, lymphocytes and fibroblasts [46,49] and type II, so far only found in Japan, with APRT activity up to 25% in haemolysates and 50% in T-lymphocyte extracts [46]. Clinical symptoms occur only when 2,8-DHA crystals are formed and all the symptoms associated with this situation ranging from fever, dysuria, haematuria, urinary retention, abdominal colic to acute renal failure. The age of diagnosis has ranged from 5 months to 74 years old. Crystalluria can occur without clinical symptoms and in several cases patients have developed chronic renal failure, some have died, several have been on dialysis and had subsequent renal transplants. Sometimes the disease was only detected at the stage of terminal renal insufficiency. In the initial cases, after the diagnosis of urolithiasis most stones were considered to be of uric acid. More recently, the use of most appropriate techniques has allowed a faster diagnosis [46,47].

Adenine and its derivatives 8-HA and 2,8-DHA are excreted in the urine by both symptomatic and asymptomatic patients and can be detected and quantitated by high performance liquid chromatography (HPLC), thin-layer chromatography (TLC) or capillary electrophoresis [46,50,51]. Uric acid in these patients is normal in plasma and urine and no other abnormal purines and pyrimidines have been detected [46].

Confirmation of APRT deficiency is made by a combination of cell studies, in which patients and heterozygotes for type I and type II deficiencies can be distinguished, and by molecular diagnostics, as well. Treatment is made by allopurinol administration and low purine diet together with high fluid intake [46,52].

3.4 Adenosine Deaminase (ADA) Deficiency

ADA is an enzyme of the purine catabolism pathway that catalyses the irreversible deamination of adenosine and 2'-deoxyadenosine to inosine and 2'-deoxyinosine, respectively, and ammonia. Inosine and 2'-deoxyinosine are converted into hypoxanthine which is either salvaged back to IMP. This can then be inter-converted back into adenosine and 2'-deoxyadenosine or into other purines, or even be catabolised to uric acid and then excreted [2, 53].

The first cases of ADA deficiency were described by Gibblet et al. [54]. Patients with this deficiency manifest symptoms like failure to thrive immediately during the first weeks of life and immunodeficiency. This immunodeficiency generally appears as pneumonia, skin or gastrointestinal tract recurrent infections as a result of a profound lymphopaenia (affecting T, B and natural killer (NK) cells) and hypogammaglobulinaemia (IgG, IgM and IgA). Any opportunistic agent can be encountered: viral, fungal, bacterial or protozoan.

Candidiasis, persistent diarrhoea, failure to thrive and absence of lymph nodes and pharyngeal lymphoid tissue are also common findings in this disease. Prominent costochondral junctions, renal and adrenal lesions as well as neurological abnormalities like spasticity, movement disorders, inability to focus and sensorineural deafness may also be pathognomonic [53,55,56]. Hepatotoxicity has also been described [56].

Deficiency of ADA is inherited in an autosomal recessive manner. In general, the degree of residual ADA activity correlates inversely with the clinical severity and the extent of accumulation of the toxic metabolites deoxyadenosine and deoxyATP. The complete deficiency of the enzyme causes severe combined immunodeficiency (SCID), a syndrome characterized by a dysfunction of both B and T lymphocytes resulting in a severe impairment of both humoral and cellular immunity. The immunodeficiency is thought to occur because immature lymphoid cells are sensitive to the toxic effects of adenosine and deoxyadenosine [53].

A delayed onset presentation of ADA affects 10 to 15% of all patients. These have a less complete form of combined immunodeficiency (CID)

usually diagnosed beyond the first year of life, within the first decade. Due to ADA deficiency, CID has been diagnosed in several patients beyond the first decade (late/adult onset). These cases suggest that there may be a class of ADA-deficient individuals in whom the immunodeficiency is compatible with long survival despite the immunologic deterioration over years [53,57]. In patients with this defect, as adenosine and 2'-deoxyadenosine cannot be degraded, they accumulate. Increased amounts of these substrates are present in the plasma and massive amounts are excreted in urine, particularly of deoxyadenosine [55-57]. Within cells, specially in the erythrocyte, deoxyadenosine is phosphorylated to deoxyATP, a minor pathway in normal conditions, accumulating in enormous concentrations and inhibiting ribonucleotide reductase, an enzyme required for normal DNA synthesis [53,55,58]. A secondary inactivation of the enzyme S-adenosylhomocysteine (SAH) hydrolase by adenosine and deoxyadenosine has also been demonstrated in lymphoblasts [59]. SAH hydrolase catalyses the reversible hydrolysis of SAH in adenosine and homocysteine consequently elevated adenosine drives the reaction in the direction of SAH formation inhibiting SAM-dependent methylation reactions in the body. Adenosine inhibits and deoxyadenosine irreversibly inactivates SAH hydrolase [53,55].

It seems that the following mechanisms, which resulted from several experiences, may be responsible for the immunodeficiency caused by ADA: deoxyATP inhibition of ribonucleotide reductase showed to inhibit T-lymphoblastoid cell lines [53,60]; moreover, deoxyATP has shown to induce apoptosis of human T-lymphoblasts and to be involved in deoxyadenosine lethality to resting T-cells by inducing DNA strand breaks and depletion of NAD and ATP [61]; besides, extracellular adenosine has shown to have multiple effects mediated by plasma membrane receptors, such as, the increase in intracellular cAMP, which seems to be lymphotoxic and to induce apoptosis in murine thymocytes and T-lymphocytes [62].

Measuring ADA activity in haemolysates using modified spectrophotometric or radiochemical methods make diagnosis of this deficiency. Both urinary excretion of deoxyadenosine, which is highly

elevated in these patients and accumulation of deoxyATP in erythrocytes can be assessed by HPLC [50,53].

Prenatal diagnosis is possible by direct enzyme assay of chorionic villi in the first trimester or of cultured amniotic cells in the second trimester. DNA-based diagnosis is also possible but in families where genotype has already been determined [53,55].

Bone marrow transplantation is the treatment of choice and can result in partial or complete immune reconstitution. When no HLA-matched marrow donor is available or in patients who are in such poor health conditions to undergo a transplantation, replacement therapy with bovine ADA covalently modified with polyethylene glycol (PEG-ADA) has partially recovered immune function avoiding opportunistic infections. Since 1990, the first human trials of somatic cell gene therapy have been achieved. At any rate, its benefit has not yet been proved [60].

3.5 Purine Nucleoside Phosphorylase (PNP) Deficiency

The pathogenic role of defective purine metabolism in the immune system, first described in ADA deficiency, has suggested that other defects of purine catabolism might cause similar syndromes.

In 1975, an immunodeficient child lacking PNP was described by Giblett et al. [63]. This rare autosomal recessive disorder is associated with a severely defective T-cell immunity combined with normal B-cell function. Thus, it presents a less severe impairment of immunological response than ADA deficiency [64,65]. The gene encoding PNP is located on chromosome 14q13 [53].

PNP catalyses the reversible conversion of inosine into hypoxanthine, of guanosine into guanine and of xanthosine into xanthine and, therefore, patients with PNP deficiency have increased concentrations of guanosine and inosine in serum and urine whereas uric acid has been markedly decreased [2,64]. The mechanism of T-cell toxicity is due to the accumulation of deoxyGTP since this nucleotide is a potent inhibitor of ribonucleotide reductase and can induce apoptosis like deoxyATP [2,53,66].

Chapter 2

Clinical manifestations of the disease include respiratory, urinary and gastrointestinal infections with an enhanced susceptibility to viral agents including herpes, cytomegalovirus and Epstein-Barr virus (EBV). Opportunistic infections have also been reported and although this has been first described as a disorder of cellular immunity, some cases suggest an impairment of humoral immunity [53,64]. The onset of recurrent infections ranges from 1 to 6 years of age and includes pneumonia, otitis, pharyngitis, varicella, diarrhoea and urinary tract infections. Neurological abnormalities, retarded motor development, mental retardation of varying degrees, behavioural problems and hypo or hypertonia have also been reported [2,53,65] apart from autoimmune disorders, reflecting B-lymphocyte hyperactivity as a consequence of T-cell lost regulation which are also common.

Facing the above data, hypouricaemia associated to T-cell lymphopenia and recurrent infections, which might be combined with neurological or autoimmune disorder, should always raise the suspicion of PNP deficiency [2,53,64].

Diagnosis is made by enzyme assay in haemolysates. DeoxyGTP, usually not detectable in red blood cells (RBCs), is elevated in this deficiency and urate concentration in serum and its excretion are low. Plasma inosine, guanosine, deoxyinosine and deoxyguanosine are elevated and there is a urinary overexcretion of these metabolites also in result of an overproduction of purines *de novo* by the interruption of the salvage HPRT reaction [53].

Prenatal diagnosis is done by measuring PNP in cultured amniotic cells or chorionic villi fibroblasts [53]. Mutation analysis has been performed in several patients and more than 30 different mutations have been described until now [53,67].

3.6 Muscle AMP Deaminase (AMPD) Deficiency

Frequently referred to as myoadenilate deaminase deficiency, this deficiency of the muscle-specific isoform of AMP deaminase, was first

described in 1978 by Fishbein et al. [68] in patients who used to present exercise-induced myalgia, rapid fatigue and cramps [69]. Two forms of the disease have been considered initially [70]: an inherited (primary) deficiency which presents exercise-related symptoms, and an acquired (secondary) deficiency, more debilitating, associated with other neuromuscular or rheumatologic disorders. However, the finding of asymptomatic patients, the high prevalence of the deficiency and absence of correlation between exercise-induced symptoms and AMP deaminase deficiency raise many questions of clinical heterogeneity to which the metabolic and molecular basis, studied for this phenomenon, still do not respond [69-71]. Now, the combined molecular and population studies suggest a third class of AMP deaminase deficiency: acquired AMPD. This form is present in carriers for the AMPD1 mutant allele who have associated rheumatologic or neuromuscular disorders and this results in further reduction of enzyme activity. Some cases of "acquired" deficiency consist of a coincidental inherited defect of the AMPD1 gene, caused by the high frequency of the mutant allele in patients with other metabolic disorders [72,73].

In humans, four AMP deaminase isoforms have been identified. Isoform M is found in muscle, L in liver and brain, and E1 and E2 are found in erythrocytes [70].

AMP deaminase converts AMP into IMP and NH_3 . The enzyme is one of the three components of the so-called "purine nucleotide cycle" (PNC), a functional unit also formed by adenylosuccinate synthetase and adenylosuccinate lyase, the enzymes involved in the regeneration of AMP [74]. The deamination of AMP into IMP, which is the source of ammonia production in skeletal muscle, is proportional to the work performed by the muscle. IMP condenses with aspartate, in a reaction catalysed by adenylosuccinate synthetase, requiring GTP. In the end, adenylosuccinate lyase cleaves the C-N bond of adenylosuccinate yielding AMP and fumarate (Figure 3). The net effect of the cycle is the conversion of aspartate into fumarate, which activates the citric acid cycle, and ammonia. AMP is maintained in equilibrium with ATP and ADP by adenylate kinase or it can

be dephosphorylated into adenosine. To pull the reaction towards formation of ATP, AMP has to be removed [70,72,74].

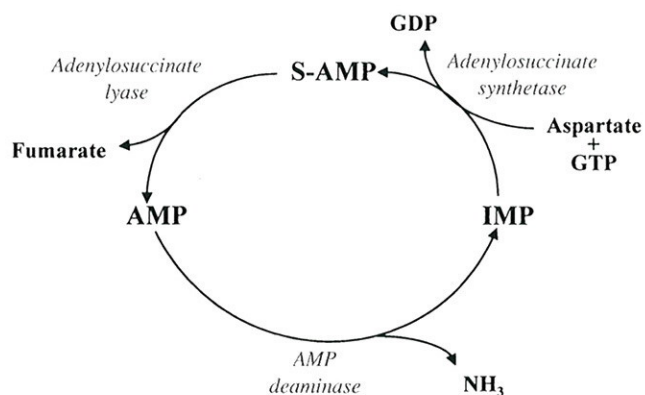

Figure 3 - The purine nucleotide cycle.

During physical exercise, the stimulation of the purine cycle leads to an increase of energy production. It can be inferred that a deficiency of AMPD drives into muscle dysfunction [70,72].

The typical clinical picture of the disease includes symptoms like muscular weakness, early fatigue, myalgia and cramps, induced or aggravated by exercise. There is a wide variability with respect to the age of onset of the clinical symptoms, ranging from early childhood to late adulthood, and asymptomatic patients have also been identified [69,70]. Myoadenylate deaminase deficiency is the most common enzyme defect in skeletal muscle. It was found in about 2-3% of all specimens in a large series of muscle biopsies [69]. The disease is inherited as an autosomal recessive trait and most of the patients reported so far are homozygous for the same nonsense mutation C34-T located in exon 2 of the AMPD1 gene, this last localized in the short arm of chromosome 1 [70,75]. Studies of the mutant allele

frequency in various populations have shown a high prevalence in African-Americans (19%), followed by Caucasians (12%) whereas, among the Japanese, none of the subjects surveyed had the mutant allele [75].

The high prevalence of the mutation, the elevated frequency of myopathy and the high rate of asymptomatic individuals can be explained by several hypotheses. The defect may not be the primary cause of myopathy and there may be other factors that together with the AMPD1 mutation cause the muscle dysfunction, or there are compensatory mechanisms protecting some individuals from the bad effects of the mutation. A good explanation for high prevalence of homozygous asymptomatic patients seems to be alternative splicing of exon 2, which results in an enzymatically active protein [69,70]. The expression of other genes that encode AMPD isoforms in muscle cells may also affect the clinical picture of the disease. In addition, co-expression of AMPD1 and AMPD3 recombinant polypeptides produces tetrameric enzymes that may maximize AMPD expression in patients [76]. Carriers for the C34T mutation may have an adaptative advantage to clinical outcome should they develop congestive heart failure [72]. The presumed homogeneity of the genetic basis made it easy to screen for this defect but recently, Gross et al. have reported 9 individuals with a heterozygous genotype from a survey of 48 patients with documented exercise-induced myalgia and AMPD deficiency [77]. In these patients, a G468T mutation was identified and the common AMPD1 mutant allele. Westernblot analysis of biopsy material did not detect any immunoreactivity from the polypeptide. These facts show that genetic tests for patients' diagnosis cannot be based solely on the detection of a single mutant allele [77].

Treatment with ribose, in order to increase the ATP rate of synthesis, has shown to be beneficial in some patients [78] but ineffective in others [79]. Ribose acts as a precursor of PRPP, stimulating *de novo* synthesis of purines or the *salvage* pathway or even as a glycolytic substance [69,70,74].

3.7 Xanthine Oxidase/Dehydrogenase (XO) Deficiency

Inherited deficiency of xanthine-oxidase (or dehydrogenase), the enzyme that catalyses the two final reactions of purine catabolism, by oxidizing hypoxanthine to xanthine and this last metabolite to uric acid [64,80] results in xanthinuria, a rather benign disorder, first described in a 4-year-old girl in 1954 by Dent and Philpot [25]. Subsequent studies have revealed that this enzyme defect may occur isolated or in combination with defects in two other molybdoenzymes: aldehyde oxidase (AO) and sulphite oxidase (SO). The combined deficiency of XO and AO results in a disease clinically similar to XO deficiency and is known as xanthinuria type II. The two types are solely characterized by the ability or inability of patients to oxidize allopurinol to oxypurinol. In type I (patients with isolated deficiency of XO), allopurinol is metabolised by aldehyde oxidase whereas, in type II, patients are unable to oxidize allopurinol [82].

In molybdenum cofactor deficiency, the activity of the three enzymes SO, AO and XO is missing and clinically it is a much more severe form. In this case, the cofactor is essential for the function of the three enzymes. This deficiency was first described in 1978 by Duran et al. [83] and the clinical picture is much more severe than that of XO deficiency. Patients exhibit symptoms like neonatal feeding difficulties, convulsions, severe neurological abnormalities, mental retardation, ocular lens dislocation and many patients display dysmorphic facial features. The disease is serious and often fatal [69,84] although less severe forms of the disease have been described [85]. Biochemically, these patients present excretion of high levels of sulphite, thiosulphate, S-sulphocysteine, taurine, xanthine and hypoxanthine and low excretion levels of uric acid. The absence of urinary urothione, a molybdopterin degradation product, is a hallmark of this deficiency [84]. The main physiological substrates of XO are hypoxanthine and xanthine, derived from the breakdown of the major purine compounds in the cell, although adenine and synthetic derivatives like allopurinol are also oxidized by this enzyme [86,87]. Under physiological conditions the enzyme exists as xanthine dehydrogenase and uses NAD^+ as the electron acceptor [80].

Xanthinuria is an autosomal recessive disease characterized by low uric acid and high xanthine in plasma and urine. Although hypoxanthine is the main purine base formed in the catabolism of adenine nucleotides, it is normally very efficiently salvaged by HPRT. In spite of being salvaged by HPRT as well, guanine is partly deaminated to xanthine by guanase and this seems to be the main source of xanthine [88]. Many patients have been detected for their very low plasma uric acid. Uric acid is usually assayed based on spectrophotometric methods using uricase whereas hypoxanthine and xanthine are assessed by HPLC in plasma and urine [89]. Detection of urothione and S-sulphocysteine in Mo-cofactor deficiency is also possible by HPLC [84,90].

The most common symptoms of XO deficiency are urolithiasis and myopathy caused by insolubility of xanthine that leads to precipitation. As a matter of fact, increased concentrations of xanthine and hypoxanthine have been found in skeletal muscle [91]. The most severe forms can drive into chronic renal failure and death [92]. In infants, the disease may present nonspecific symptoms like irritability and poor feeding [80].

There is no specific treatment for XO or for Mo-cofactor deficiency. Therefore, a low purine diet and high fluid intake are recommended in the first case and restriction of the intake of sulphur-containing amino acids precursors in the second case [80,84]. In patients with some residual XO activity, the use of allopurinol has been advocated in order to block the conversion of hypoxanthine into xanthine, which is far less soluble [64].

The human XO gene is located on chromosome 2p22. The purified enzyme is a dimer of two identical subunits of ~150kDa and either subunit consists of two domains. Several mutations in the XO gene have been described as a cause of xanthinuria type I, whereas type II seems to result from failure to incorporate a sulphur atom into the molybdenum centre of both XO and AO [80].

The genes for most of the molybdenum cofactor biosynthetic enzymes have been cloned and some mutations have been identified. Two complementation classes of patients have also been identified: group A comprises patients with defective genes coding for early steps of the biosynthetic pathway (MOCS1A or MSCS1B) and group B is composed of

patients with mutations in molybdopterin synthase or molybdopterin synthase sulphurylase [83].

3.8 Adenylosuccinate Lyase (ADSL) Deficiency

ADSL deficiency, the first enzyme deficiency reported on the *de novo* pathway of purine synthesis in the human being, was discovered by Jaeken and Van den Berghe in 1984 [93] and is inherited in an autosomal recessive manner. The ADSL gene is located on chromosome 22q [94].

The ADSL enzyme, also termed adenylosuccinase, catalyses two different steps in the synthesis of purine nucleotides: one is the conversion of succinylaminoimidazole carboxamide ribotide (SAICAR) into aminoimidazole carboxamide ribotide (AICAR) and fumarate along the *de novo* pathway; the other is a step of the purine nucleotide cycle which consists of the formation of adenosine monophosphate and fumarate from adenylosuccinate [70,74,94].

Moderate to severe psychomotor retardation is the main symptom of the disease frequently accompanied by epilepsy, after the first years, growth retardation and muscular wasting. Autistic features like failure to make eye to eye contact, repetitive behaviour, autoagressivity, temper tantrums and agitation have been found in about half of the patients [95]. Auditory and visual responses, as well as nerve conduction velocities and electromyography, are normal. Electroencephalography is usually normal during infancy but frequently displays epileptic disturbances later on. However, a case of epileptic seizures followed by sudden death, has been described in a male infant just after birth [96]. Magnetic resonance imaging (MRI) and computed tomography show hypotrophy or hypoplasia of the cerebellum, particularly of the vermis [97].

Two subtypes of ADSL deficiency have been described [70,97]. Type I is accompanied by profound mental retardation and type II by mild retardation. More recently, an intermediate clinical form has been described [98] and a mild case of ADSL deficiency, with delayed motor development, dominated by hypotonia, has been reported [99].

Diagnosis of this disease is based on the presence of succinylaminoimidazole carboxamide riboside (SAICArboside) and succinyladenosine (S-adenosine) in urine and CSF. These are normally undetectable succinylpurines, which are the dephosphorylated derivatives of SAICAR and S-AMP, the normal substrates of ADSL [94,97]. Both SAICArboside and S-adenosine accumulate in CSF but are low in the plasma because of their efficient renal elimination.

Succinylpurines can be detected by a modified Bratton–Marshall test performed on fresh urine. It is a good method for systematic screening, although it can give false positive results in patients receiving antibiotics, particularly sulphonamides and/or antiepileptics. Other techniques like two-dimensional thin-layer chromatography of urinary imidazoles, previously isolated via a cation exchange resin [100], capillary electrophoresis [101] and HPLC with UV detection can also be used, the last one being the method of choice for final diagnosis. LC-MS methods are also being developed [94,102].

Symptoms of ADSL deficiency are probably caused by the neurotoxic effects of accumulating succinylpurines and impaired synthesis of purine nucleotides. In profoundly retarded type I patients, S-adenosine and SAICArboside ratio in body fluids is between 1 and 2. In the less retarded, type II patients, the ratio is between 4 and 5, which means that the SAICArboside values are to be compared with those of type I patients. And yet, S-adenosine is markedly higher. Patients with an intermediate symptomatology also have ratios between 1 and 2 [70,97].

In the human being, ADSL activity has been measured in liver, kidney, muscle, lymphocytes, granulocytes and erythrocytes. A number of observations indicate genetic heterogeneity of the defect and the existence of ADSL isoforms. Measurements of adenylosuccinase activity with S-AMP and SAICAR as substrates showed that both activities were decreased in parallel in the liver and fibroblast of profoundly retarded patients. Nevertheless, in fibroblasts from a mildly retarded patient, activity with S-AMP was reduced to 3% whereas that of SAICAR was 30% of control. This provides an explanation for the higher S-adenosine/SAICArboside ratio in the body fluids of mildly affected patients [94,97]. The enzyme data

obtained until now suggest that in type I patients the ADSL defect is a structural one, causing decreased stability and that type II is a catalytic defect that impairs binding to S-AMP in a greater extent than binding to SAICAR [97]. Several different mutations of the ADSL locus have already been described [94].

Concerning the two main hypothesis to explain the symptoms of the disease, impaired synthesis of purine nucleotides and toxic effects of succinylpurines, the many experiments performed indicate that symptoms are not caused by purine nucleotide deficiency and are more likely due to accumulation of succinylpurines. Moreover, the observation of a strikingly less severe psychomotor retardation in type II patients with higher ratios and similar SAICAriboside levels suggests that SAICAriboside is the offending compound and that S-adenosine protects against its toxic effects. The resemblance of succinylpurines and adenosine raised the hypothesis that they might interfere with cerebral adenosine receptors. However, studies in rat cerebral cortex failed to show interference of the two succinylpurines with binding of adenosine. Other hypothetical mechanisms, like impairment of the purine nucleotide cycle, have been suggested [97]. Most recently, studies of SAICAriboside in rats have shown this to cause neuron damage in specific regions of the hippocampus [97].

Treatment with oral supplements of adenine and allopurinol has been tried in several patients with the objective of replenishing hypothetically decreased concentrations of adenine nucleotides. Adenine can be incorporated by way of APRT and allopurinol avoids conversion of adenine into the nephrotoxic product 2,8-DHA by XDH. No clinical improvement has been recorded, just acceleration of growth [94,97]. D-ribose administration has been tried to stimulate de novo synthesis of purines and was accompanied by progressive reduction in seizure frequency [103]. However, further studies are still required to exclude toxic side effects.

The prognosis of these patients is poor and several patients, particularly those of type I, have died in early infancy [94,96,97].

3.9 Deoxyguanosine Kinase (dGK) Deficiency

Primary and secondary mitochondrial DNA depletion syndromes are a clinically heterogeneous group of disorders characterized by reduction of the mitochondrial DNA (mtDNA) content, which can affect multiple organ systems. The structure, size and sequence of the mtDNA are normal but there is a quantitative reduction in mtDNA copy number [104].

Recently, mutations in the deoxyguanosine kinase gene encoding the mitochondrial deoxyguanosine kinase, an essential protein in the nucleotide *salvage* pathway which is responsible for the phosphorylation of purine deoxyribonucleosides in the mitochondrial matrix compartment, have been identified as a cause of hepatocerebral mitochondrial DNA depletion syndromes in three families [105]. Actually, mitochondrial nucleotide synthesis, via the *salvage* pathway, is of major importance for mitochondrial DNA maintenance since *de novo* enzymes are not present in the mitochondria. After this discovery, other dGK mutations have been described in patients with the hepatocerebral form of mitochondrial DNA depletion syndrome [106,107]. Yet studies have shown a low frequency of these mutations suggesting that dGK is not the only gene responsible for mitochondrial DNA depletion in liver [104,107,108].

Biochemical analysis of respiratory chain enzymes in clinically affected tissues of several patients showed decreased activity of complexes containing mtDNA-encoded subunits and another finding was mtDNA depletion in the liver [105,107].

The general phenotype for mutations in the deoxyguanosine kinase gene has been identified as hepatic failure and encephalopathy. This tissue selectivity, in spite of the ubiquitous nature of the enzyme, has not yet been clarified. A proposed explanation is that the cytosolic enzyme deoxycytidine kinase (dCK), which has overlapping substrate specificity with dGK in phosphorylating deoxyguanosine and deoxyadenosine, has a very low activity in high energy demanding organs like brain and liver, making these highly dependent on dGK [109]. The decreasing abundance of mtDNA in the muscle of a dGK deficient patient and the demonstration of decreasing mtDNA content in myoblasts also suggest an age-dependent protective

mechanism, a time window during which nuclear nucleotide synthesis provides mitochondrial needs in every organ [109].

3.10 Renal Tubular Defects of Uric Acid Transport

Hereditary renal hypouricaemia can be caused by an isolated tubular defect of urate transport and in this case the deficiency is denominated as true hereditary renal hypouricaemia, or by a generalized disturbance of membrane transport like in Fanconi or Hartnup syndrome [110-112].

Hereditary renal hypouricaemia was first described by Greene et al., in 1972 [113] and is inherited in an autosomal recessive manner manifesting as hypouricaemia and elevated renal urate clearance. Increased renal uric acid clearance can be caused by defective reabsorption or increased secretion. Uric acid is freely filtered at the glomerulus, most of it is then efficiently reabsorbed in the proximal tubules by active transport and it is also secreted, although the exact localization has not been established. And yet, it seems to be at the terminal portion of the proximal tubule. A small postsecretory reabsorption, by a mechanism different from that of presecretory reabsorption, was demonstrated to occur through the discovery of patients possessing renal hypouricaemia due to a postsecretory reabsorption defect [112,114,115]. Based on this model of uric acid transport in the proximal tubule, five transport abnormalities should be considered as the cause of hypouricaemia: a total transport defect (with no reabsorption nor secretion), total reabsorption, presecretory or postsecretory defect and finally increased secretion [110]. Most of the patients have shown to be affected with the presecretory reabsorption defect and a postsecretory defect has not yet been documented [110].

Fanconi syndrome can be idiopathic [116,117], secondary to metabolic diseases like cystinosis, galactosaemia, tyrosinaemia, hereditary fructose intolerance, glycogen storage disease, Lowe syndrome and Wilson disease, or acquired through exposure to toxic agents [105,118-123]. It is characterized by a generalized dysfunction of the proximal renal tubule and a vitamin D-resistant metabolic bone disease, resulting in increased urinary

excretion of amino acids, glucose, phosphate, bicarbonate and uric acid. Water, sodium, potassium, calcium, magnesium, low-molecular-weight proteins usually reabsorbed can also be excessively excreted, causing dehydration, metabolic acidosis, rickets and growth retardation [121-122]. The renal Fanconi syndrome can result either from multiple transport dysfunctions in the proximal tubule or both proximal and distal tubule. It seems that mutations affect components of the transport mechanism, other than the carriers per se. Inhibition of endocytosis mediated by megalin, a membrane glycoprotein, which is a receptor for many ligands, may be responsible for the permeability defect [124,125]. The interruption of membrane recycling by toxins can trap membrane receptors and transporters in endosomes resulting in a dysfunction of reabsorptive mechanisms. An impaired mitochondrial production of ATP and reduced Na^+, K^+ -ATPase have also been suggested as pathogenic mechanisms [126]. Bioactive peptides, not usually present in normal urine, have been found in urines of these patients by liquid chromatography / tandem MS (LC-MS/MS) analysis [127].

3.11 Identification of Purine Metabolism Defects

Uric acid, as the end product of purine catabolic pathway, being a routine clinical chemistry parameter is a good indicator of abnormal function of purine metabolism. It is usually measured in the plasma and urine and in this fluid it is the uric acid to creatinine ratio that is evaluated [102,128]. However, not all the defects are accompanied by changes in uric acid levels. Adenylosuccinase and adenosine deaminase deficiency fit in this last category [102].

In general, purine metabolism deficiencies can be diagnosed by laboratory detection of abnormal concentrations of metabolites in urine, plasma, CSF and/or erythrocytes or, occasionally, absence of normal metabolites. The enzyme activities may also be evaluated in erythrocytes, lymphocytes, fibroblasts or biopsy samples [50]. Several methods of sensitive detection are now available, especially chromatographic methods like anion exchange

Chapter 2

/ reversed phase / ion-pair HPLC with in-line photodiode-array detection or radiodetection [102], liquid chromatography-mass spectrometry (LC-MS) [129] and tandem mass spectrometry (MS-MS) [130]. Capillary electrophoresis [131,132] and nuclear magnetic resonance (NMR) spectroscopy [133] have also been used but in a smaller scale.

Advances in molecular techniques now permit the characterization of gene mutations responsible for disease among patients. The most precise methods use direct amplification of genomic DNA by the polymerase chain reaction (PCR) and sequence analysis with primers for each of the exons [27,35,46,53,64,72].

Prenatal diagnosis is available and has been used in the detection of some of these disorders by using chorionic villi in the first trimester or amniotic fluid and amniotic fluid cells in the second trimester [27,64].

4. ONE-CARBON UNIT METABOLISM

Overall one-carbon metabolism is a complex network of pathways which involve the transfer of one-carbon groups from one compound to another (Figure 4). Coenzymes for these methylation reactions include folates, cobalamin, pyridoxine and zinc. One-carbon units contribute to purine and thymidilate biosynthesis, amino acid metabolism, phospholipid and protein biosynthesis, neurotransmitter synthesis, epigenetic modification of DNA and functional modifications of RNA [134-136].

The major source of one-carbon units is the amino acid L-serine derived from glycolytic intermediates in its interconversion to glycine. In this reaction the transfer of a carbon unit to tetrahydrofolate (THF), a carrier of one-carbon units that will be discussed below, generates 5,10-methylenetetrahydrofolate (5,10-MTHF). This last folate form is reduced to 5-methyltetrahydrofolate (5-MTHF), a methyl donor in the remethylation of homocysteine to methionine. Furthermore, betaine, derived from oxidation of choline, is a methyl donor in this same pathway giving origin to dimethylglycine [135,137].

Another important source of methyl groups is glycine cleavage reaction yielding one-carbon units that are transferred to 5,10-methylenetetrahydrofolate [134].

As the transfer potential of tetrahydrofolate carrying methyl groups is not high enough for most biosynthetic methylations, the activated methyl donor is S-adenosylmethionine (SAM). SAM derives from methionine and is the major methyl donor for the various methyltransferases in reactions such as the biosynthesis of creatine, the reaction that consumes more methyl groups than all other transmethylation together [134,137].

From the evaluation of the metabolic pathways that lead to synthesis of the activated methyl donor SAM, we can draw the conclusion that folic acid, betaine, cobalamin and zinc have the potential to affect methylation [135]. Once an enzymatic defect in any of the above-mentioned pathways is due to affect the whole one-carbon metabolism, each of them will be examined in more detail.

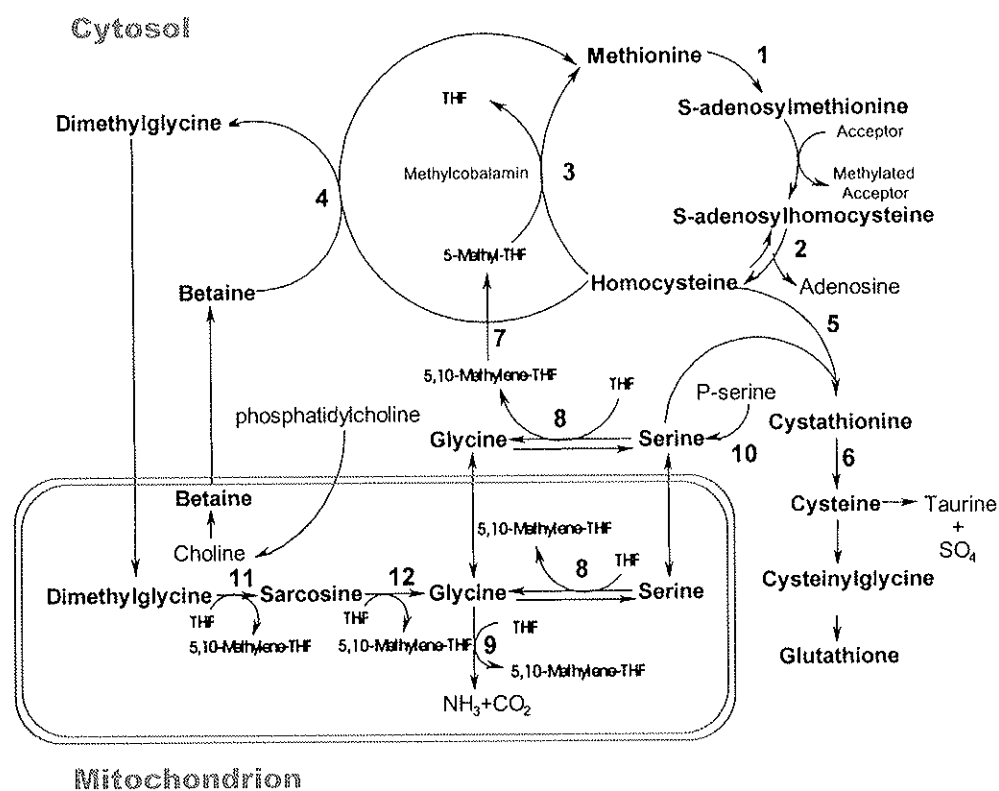

Figure 4- One-carbon group metabolism. Adapted from [213].

The enzymes catalysing the reactions are: 1. MAT; 2. SAHH; 3. MS; 4. BHMT; 5. CBS; 6. γ-cystathionase; 7. MTHF-reductase; 8. SHMT; 9. GCS; 10. PSP; 11. DMGDH; 12. SDH.

5. HOMOCYSTEINE METABOLISM AND REGULATION

S-adenosylmethionine as mentioned above, is the major methyl donor of most cellular transmethylation reactions yielding vital compounds such as creatinine or methylated DNA [138]. It is synthesised in the methylation pathway by transfer of an adenosyl group from ATP to methionine catalysed by methionine adenosyltransferase (MAT). SAM irreversibly transfers its methyl group to a methyl acceptor originating S-adenosylhomocysteine

(SAH) [135,137,138]. SAH, produced by all SAM-requiring methyltransferases, is hydrolysed to adenosine and homocysteine by S-adenosylhomocysteine hydrolase and the rapid removal of those products ensures predominance of this reaction. Moreover, SAH is a strong inhibitor of the methyltransferases. Homocysteine formed can then be reconverted to methionine by methionine synthase (MS) and this pathway is called *remethylation* or it can be catabolised via the *transsulphuration* pathway [135,138,139].

An alternative pathway of remethylation of homocysteine is catalysed by betaine-homocysteine methyltransferase (BHMT) using betaine (derived from oxidation of choline), which is hydrolysed to dimethylglycine. *De novo* synthesis of methionine does not occur. It can only be regenerated by these two remethylation pathways [135,139].

Lack of methyl donor agents such as folate or betaine, or of the cofactors methylcobalamin and zinc, can result in accumulation of homocysteine and reduced levels of SAM [137]. When homocysteine accumulates, once SAH hydrolysis is a reversible reaction, the result can be increased levels of SAH and decreased SAM/SAH ratios (the methylation index) [135,138,139]. Many SAM-dependent methyltransferases are strongly inhibited by SAH and it has been calculated that when the SAM/SAH ratio is 4, a variety of methyltransferases will be inhibited by 10 to 60% [138].

The major alternative to methylation of homocysteine is the transsulphuration pathway. The first step of this pathway is the condensation of homocysteine with serine catalysed by cystathionine- β -synthase (CBS) yielding cystathionine, which is then cleaved to cysteine and α -oxobutyrate by γ -cystathionase. Both CBS and γ -cystathionase require vitamin B₆ (pyridoxal 5'-phosphate; PLP) [137,138].

Oxidation of the sulphur atom from cysteine occurs through a number of reactions. First, cysteine is oxidized to cysteine sulphinate by cysteine dioxygenase; then, transamination with α -oxoglutarate by cysteine sulphinate: α -oxoglutarate aminotransferase yields pyruvate and sulphite, this last oxidizing to sulphate by sulphite-oxidase [138]. Cysteine can also be decarboxylated yielding hypotaurine and taurine, an important amino acid with neurotransmitter function [138].

5.1 Control of Homocysteine Metabolism

Increased levels of SAM, due to high methionine levels, favour trans-sulphuration due to SAM inhibition of low- K_m isoenzymes of methionine adenosyltransferase and inactivation of betaine methyltransferase. In contrast, the high- K_m isoenzymes of methionine adenosyltransferase and cystathionine- β -synthase are activated. What is more, SAM inhibits methylene-THF reductase to reduce 5-methyl-THF and methionine synthase activity. Methionine, on the other hand, inhibits betaine and methyl-THF dependent homocysteine methyltransferases [138].

5.2 Disorders of Homocysteine Metabolism

Cystathionine β -synthase deficiency is the most important disorder of homocysteine metabolism because it is associated with severe abnormalities of various organs and systems [140]. Once it generates a bigger usage of one-carbon units, it affects methylation metabolism.

Methionine adenosyltransferase deficiency and γ -cystathionase deficiency are diseases that usually do not require treatment. Sulphite oxidase deficiency, already referred to above, has no available treatment at present [140].

5.2.1 Methionine Adenosyltransferase (MAT) Deficiency

At least two different structural genes for MAT located on chromosomes 10q22 and 2p11.2 are known. They encode to different holoenzymes which differ in their kinetic properties [137].

This seems to be a benign disorder characterized by a deficiency solely of the hepatic form of the enzyme. Methionine concentrations are elevated in tissues and body fluids; yet SAM is not deficient in most cases. In these cases, an alternative metabolism of methionine results in the formation of 4-

methylthio-3-oxobutyrate, a transamination product, and of dimethyl sulphide, which causes a distinct odour of the breath [140].

5.2.2 Cystathionine β -synthase (CBS) Deficiency

CBS deficiency leads to an accumulation of homocysteine as well as methionine, SAM and SAH possibly due to enhanced rates of homocysteine methylation and to a lack of cystathionine with low levels of cysteine. The sulphhydryl groups of homocysteine molecules easily react with one another leading to a great number of disulphide compounds such as homocystine, homocysteine-cysteine, protein-bound homocysteine, homocysteine-cysteinylglycine and mixed disulphide [137,140]. The sum of free and bound homocysteine constitutes total homocysteine. Other biochemical abnormalities include plasma concentration increase of ornithine [141], copper [142], ceruloplasmin [140] and decrease of serine and glycine in cerebrospinal fluid (CSF) but not in the plasma, possibly due to increased methylation of homocysteine, through a bigger usage of one-carbon units [143,144]. It follows that methionine levels are important for differential diagnosis of remethylation and transsulphuration defects, being low or high, respectively. They are also important for monitoring therapeutics [145].

This deficiency is associated with severe abnormalities of four organs or organ systems: the eye, skeleton, central nervous and vascular system [140]. Ectopia lentis is the most consistent finding. Mental retardation is often the first sign of CBS deficiency, presenting as developmental delay during the first two years of life, seizures, abnormal electroencephalograms and extrapyramidal disturbances [140,146].

On the one hand, the intracellular accumulation of homocysteine is probably the main cause of vascular damage, which may lead to endothelial cell dysfunction and abnormalities in platelets and coagulation factors. All these factors contribute to thromboembolic complications. On the other hand, abnormalities of skin, joints and skeleton seem to be caused by abnormal cross-linking of collagen and damage of zonular fibres of the lens by disturbed fibrillin structure [140].

Chapter 2

Methods for total homocysteine determination include enzymatic assays, gas chromatography-mass spectrometry, liquid chromatography-fluorescence detection with precolumn derivatization, liquid chromatography-electrochemical detection and liquid-chromatography with post-column derivatization, including the amino acid analyser. All these analyses imply treatment of whole plasma /serum with a reductant [147].

Diagnosis can be achieved by determination of free homocysteine by classical ion-exchange chromatography of plasma which must be immediately deproteinized to avoid disulphide amino acids of binding to proteins. Nevertheless, false-negatives can be obtained in low-dose pyridoxine responsive patients if taking multivitamin tablets. In order to complement this analysis and monitor therapy, prior treatment of plasma samples with reducing agents like dithioreitol is a good approach and allows measurement of total homocysteine with great sensitivity [140,145].

In order to investigate mild disturbances of homocysteine metabolism or to measure normal levels of total homocysteine in plasma and CSF, greater sensitivity is required and can only be afforded by high performance liquid-chromatography, the reference method. This method uses derivatization procedures and fluorescence detection [145].

Confirmation of this deficiency has been assessed by enzymatic activity in fibroblasts, phytohemagglutinin-stimulated lymphocytes or liver biopsies [140,148]. Prenatal diagnosis has been successfully performed by direct CBS assay in cultured amniotic cells. However, it is not possible in chorionic villi due to the very low activity of the enzyme in this tissue [145]. Molecular diagnosis is an additional tool in diagnosis. Many mutations have been described since the sequence of the gene which has been mapped to chromosome 21q22.3 and the existence of linked, double mutations in the same allele has been reported [138]. Heterozygote detection and mutation studies are important because of variable phenotype expression [149] although rare mutations imply a continuing role on metabolite and enzyme studies [138].

Therapy with pyridoxine has shown to be effective in some patients but not in others depending, among other factors, on the CBS residual activity although the link between pyridoxine responsiveness and CBS activity has

shown to be a complex one [138,150]. At any rate, some of the responsive patients normalize their homocysteinaemia, decrease their hypermethioninaemia and increase their cystinaemia to nearly normal values. Some of the B₆ non-responsive patients respond after folate replenishment and therefore, folic acid addition to treatment is an important requirement [151]. In patients who do not respond to pyridoxine and even in those who respond incompletely, a low methionine and high cysteine diet must be introduced [140]. Betaine is frequently used to lower homocysteine levels in older children and adults with difficulties in the dietary therapy. Surtees et al. [143] have shown that this therapy lowers CSF and plasma total homocysteine.

6. FOLIC ACID IN ONE-CARBON METABOLISM

Methionine synthase (5-Methyltetrahydrofolate-homocysteine methyltransferase) catalyses the transfer of a methyl group from 5-methyltetrahydrofolate to homocysteine producing methionine, where 5-MTHF is reduced to tetrahydrofolate. Methionine synthase requires cobalamin (vitamin B₁₂) in the form of methylcobalamin (MeCbl) as a cofactor [139].

Tetrahydrofolate, then, serves as an acceptor of one-carbon units in degradative reactions, the major part coming from the conversion of serine into glycine, leading to 5,10-methylenetetrahydrofolate. This form is reduced to 5-MTHF releasing methyl groups that are used in thymidilate and purine biosynthesis [139].

6.1 Metabolic Pathways and Enzymes

Folic acid or pteroylglutamic acid and its related folates or pteridine compounds respectively have a fundamental role in cell growth and division as coenzymes in a number of critical one-carbon transfer reactions, including those involved in methionine, serine, deoxythymidilate, purines

Chapter 2

biosynthesis and reactions of histidine and purines degradation [152]. It is thus the co-factor in one-carbon metabolism [153].

Dietary folates exist mainly in polyglutamate forms which must be hydrolysed to the monoglutamyl form in the intestine before absorption can occur [153].

The biologically active folates are substituted derivatives of 5,6,7,8-tetrahydrofolic acid (THF) (Figure 5). There are at least three states of reduction of the pyrazine group, six different 1-carbon groups substituted at positions N^5 , N^{10} , or both and there are also gamma glutamyl peptide chains of varying length linked to the gamma carboxyl group of the glutamic residue. 5-Methyl-THF is the predominant form of folate in serum and in many tissues.

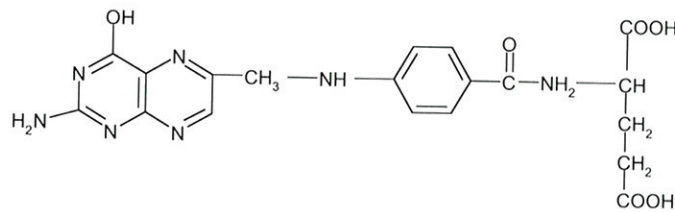

Figure 5 – Tetrahydrofolic acid.

Folic acid is reduced to dihydrofolate (DHF) and then to tetrahydrofolate, both reactions being catalysed by dihydrofolate reductase. Tetrahydrofolate and formate by the action of 10-formyl-THF synthase are converted into the one-carbon carrier derivative, 10-formyl-THF, which is then converted into 5,10-methenyl-THF by 5,10-methenyl-THF cyclohydrolase, a reversibly catalysed reaction. 5,10-methenyl THF is then reversibly converted into 5,10-methylene-THF by the enzyme 5,10-methylene-THF dehydrogenase. Both 5,10-methenyl-THF and 10-formyl-THF participate in the biosynthesis

of purines by the introduction of carbon atoms 2 and 8 in the purine ring [152-154].

As a result of histidine catabolism, a formimino group is transferred to THF by glutamate formiminotransferase to form 5-formimino-THF followed by the release of ammonia by the action of cyclodeaminase and formation of 5,10-methenyl-THF. The two enzyme activities are catalysed by a single polypeptide which forms an octameric enzyme [154] (Figure 6).

As serine and glycine are the most important sources of one-carbon units, entry into the active one-carbon pool of intermediates is by way of 5,10-methylene-THF. Serine hydroxymethyltransferase catalyses the cleavage of serine to glycine and 5,10-methylene-THF as will be shown below. In mitochondria, glycine is also metabolised to 5,10-methylene-THF plus carbon dioxide and ammonia by the glycine cleavage system [152]. The interconversion of glycine-serine and the glycine cleavage system are though central to folate metabolism [153].

5,10-methylene-THF is used unchanged in the synthesis of dTMP by thymidilate synthase (5,10-methylene-THF:dUMP C-methyl-transferase) with oxidation of the tetrahydrofolate donor to dihydrofolate, by opposition to all the interconversions of folates which involve exchange of side chains between tetrahydrofolates.

5,10-methylene-THF is reduced to 5-methyl-THF by 5,10-methylene-THF reductase, the first committed step in the biosynthesis of methyl groups. The biosynthesis of methionine from methylation of homocysteine is catalysed by methionine synthase (5-methyltetrahydrofolate-homocysteine methyltransferase) as already seen above, where 5-methyl-THF is converted into THF. It is this reaction that links folate metabolism to homocysteine.

In the complete reaction, the methyl group from 5-methyl-THF is transferred to enzyme-bound cob(I)alamin to form methylcobalamin, then it is transferred to homocysteine, producing methionine and regenerating cob(I)alamin. After a number of cycles, the enzyme-bound cob(I)alamin oxidizes spontaneously to inactive, enzyme-bound cob(II)alamin, and a reducing system and adenosylmethionine are required to reform methylcobalamine and reactivate the enzyme [154]. 5,10-methylene-THF is also oxidized to 10-formyl-THF for use in the purine synthesis. 10-formyl-

Chapter 2

THF plays a role in the reactions of 5-aminoimidazole-4-carboxamide ribonucleotide formyltransferase and of glycinamide ribonucleotide formyltransferase [153]. 10-Formyl-THF dehydrogenase releases excess active single-carbon fragments from the folate pool and generates THF and carbon dioxide. Its activity serves to maintain the THF pool to permit acceptance of single-carbons in folate-dependent reactions.

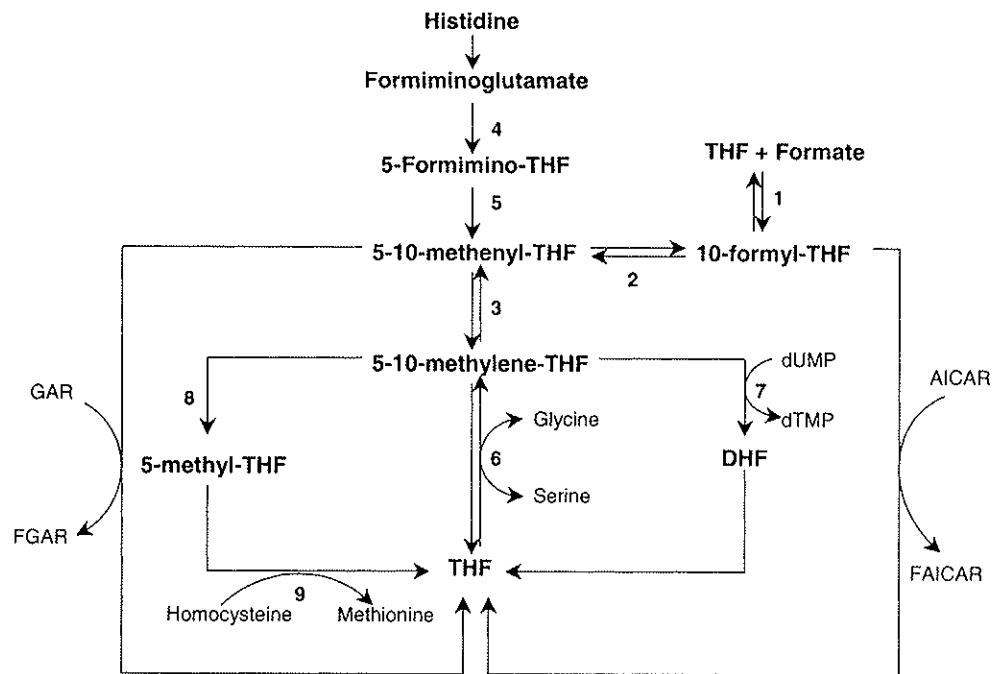

Figure 6 – Major metabolic pathways of folate.

The enzymes catalysing the reactions are: 1. 10-Formyl-THF synthase; 2. 5,10-Methenyl-THF cyclohydrolase; 3. 5,10-Methylene-THF dehydrogenase; 4. Glutamate formiminotransferase; 5. Cyclodeaminase; 6. Serine hydroxymethyltransferase; 7. Thymidilate synthase; 8. 5,10-Methylene-THF reductase; 9. Methionine synthase.

6.1.1 Hereditary Folate Malabsorption

This disease is characterized by severe megaloblastic anaemia, diarrhoea, failure to thrive and neurological signs in the first months of life. Biochemical findings are increased formiminoglutamic (FIGLU) acid excretion, especially after histidine loading, and high urinary orotic acid. Oral folate treatment has not been effective in most patients whereas systemic therapy corrected anaemia. Data obtained until now pinpoints to the existence of a specific carrier for folate both at the level of the intestine and the choroid plexus. In these patients the system is blocked and there is no absorption of oxidized or reduced folates. A cDNA for the intestinal transporter has been cloned [155].

6.1.2 Cellular Uptake Defects

Some cellular uptake defects have been described although they are still not clarified. One is a possible defect of the uptake of methyl-THF by bone marrow cells and lymphocytes [156] and the other is a transport defect, which has affected bone marrow and erythrocytes but not lymphocytes in two patients with dyserythropoiesis and without anaemia [157].

Another defect in the isolated transport of folate into the CSF, which may be a variant of hereditary folate malabsorption, was described in a patient with normal serum and red blood cell folate levels but deficiency in the CSF with progressive neurological disease [153,154].

6.1.3 Glutamate Formiminotransferase Deficiency

About twenty patients have been described but the clinical significance of this enzyme deficiency is still unclear [152,153,157]. The age of diagnosis varied between several months and 42 years old and some of these patients presented seizures, some with mental retardation and others with speech delay. Haematological findings were normal to high serum folate and cobalamin levels. Increased serum and urinary formiminoglutamate

Chapter 2

(FIGLU) were found in some cases only after histidine loading. High histidine levels in serum and urine occurred in several cases and occasionally, hypomethioninaemia [152]. Urinary excretion of AICAR, hydantoin-5-propionate and 4-imidazolone-5-propionate have also been reported [158,159].

Two distinct phenotypes have been established. In the most severe, mental and physical retardation with neurological abnormalities, hypotonia, cortical atrophy and abnormal electroencephalograms have been described. In the milder form there was no mental retardation but there was a massive excretion of FIGLU. The enzymatic basis remains to be fully explained but it has been suggested that the severe form is associated with a block in the cyclodeaminase activity and the milder form with a block in the formiminotransferase activity, although no enzyme measurements have been taken [152,157].

Treatment with folates has been tried in some of the patients but has only given good results in two of them. One patient responded to methionine supplementation. Judgment of treatment has been done by evaluation of the decrease in urinary FIGLU [152].

6.1.4 Methylenetetrahydrofolate Reductase (MTHFR) Deficiency

This condition is the most clearly established inherited disorder of folate metabolism and constitutes the second commonest homozygous deficiency causing severe hyperhomocysteinaemia [154]. It is an autosomal recessive disorder and the gene is located on chromosome 1p36.3 [152].

Methylene-THF reductase catalyses the NADPH linked reduction of 5,10-methylene-THF to 5-methyl-THF. This reaction is a control point for the entry of folate coenzymes in the homocysteine remethylation pathway, since 5-methyl-THF serves as the methyl donor for the methionine synthase catalysed transformation of homocysteine into methionine [138,152]. The reaction catalysed by MTHFR is irreversible in physiological conditions and the levels of S-adenosylmethionine, the one-carbon unit supplier of

6.1.1 Hereditary Folate Malabsorption

This disease is characterized by severe megaloblastic anaemia, diarrhoea, failure to thrive and neurological signs in the first months of life. Biochemical findings are increased formiminoglutamic (FIGLU) acid excretion, especially after histidine loading, and high urinary orotic acid. Oral folate treatment has not been effective in most patients whereas systemic therapy corrected anaemia. Data obtained until now pinpoints to the existence of a specific carrier for folate both at the level of the intestine and the choroid plexus. In these patients the system is blocked and there is no absorption of oxidized or reduced folates. A cDNA for the intestinal transporter has been cloned [155].

6.1.2 Cellular Uptake Defects

Some cellular uptake defects have been described although they are still not clarified. One is a possible defect of the uptake of methyl-THF by bone marrow cells and lymphocytes [156] and the other is a transport defect, which has affected bone marrow and erythrocytes but not lymphocytes in two patients with dyserythropoiesis and without anaemia [157].

Another defect in the isolated transport of folate into the CSF, which may be a variant of hereditary folate malabsorption, was described in a patient with normal serum and red blood cell folate levels but deficiency in the CSF with progressive neurological disease [153,154].

6.1.3 Glutamate Formiminotransferase Deficiency

About twenty patients have been described but the clinical significance of this enzyme deficiency is still unclear [152,153,157]. The age of diagnosis varied between several months and 42 years old and some of these patients presented seizures, some with mental retardation and others with speech delay. Haematological findings were normal to high serum folate and cobalamin levels. Increased serum and urinary formiminoglutamate

Chapter 2

(FIGLU) were found in some cases only after histidine loading. High histidine levels in serum and urine occurred in several cases and occasionally, hypomethioninaemia [152]. Urinary excretion of AICAR, hydantoin-5-propionate and 4-imidazolone-5-propionate have also been reported [158,159].

Two distinct phenotypes have been established. In the most severe, mental and physical retardation with neurological abnormalities, hypotonia, cortical atrophy and abnormal electroencephalograms have been described. In the milder form there was no mental retardation but there was a massive excretion of FIGLU. The enzymatic basis remains to be fully explained but it has been suggested that the severe form is associated with a block in the cyclodeaminase activity and the milder form with a block in the formiminotransferase activity, although no enzyme measurements have been taken [152,157].

Treatment with folates has been tried in some of the patients but has only given good results in two of them. One patient responded to methionine supplementation. Judgment of treatment has been done by evaluation of the decrease in urinary FIGLU [152].

6.1.4 Methylenetetrahydrofolate Reductase (MTHFR) Deficiency

This condition is the most clearly established inherited disorder of folate metabolism and constitutes the second commonest homozygous deficiency causing severe hyperhomocysteinaemia [154]. It is an autosomal recessive disorder and the gene is located on chromosome 1p36.3 [152].

Methylene-THF reductase catalyses the NADPH linked reduction of 5,10-methylene-THF to 5-methyl-THF. This reaction is a control point for the entry of folate coenzymes in the homocysteine remethylation pathway, since 5-methyl-THF serves as the methyl donor for the methionine synthase catalysed transformation of homocysteine into methionine [138,152]. The reaction catalysed by MTHFR is irreversible in physiological conditions and the levels of S-adenosylmethionine, the one-carbon unit supplier of

methylation reactions, which is an inhibitor, regulates this enzyme activity [152,159].

The biochemical features of this disease include moderate excretion levels of homocysteine, hyperhomocysteinaemia and hypomethioninaemia due to reduced remethylation of homocysteine, low intracellular methyl-THF and decreased neurotransmitter levels. Serum folate concentration may sometimes be low, cobalamin is normal [152,160] and low levels of SAM have been described [161,162]. Another interesting finding was vascular disease, which seems to be the major cause of death in these patients. Studies have shown that patients with coronary artery disease have lower levels of 5-methyl-THF than controls [163] and it seems that a combination of MTHFR deficiency and Factor V may contribute to vascular pathology [164]. All these findings indicate a direct relationship between these metabolites (SAM, folates, homocysteine). Megaloblastic anaemia is hardly present, suggesting no impairment of purine and pyrimidine biosynthesis [152].

The clinical manifestations vary and their onset has ranged from infancy to adulthood. The commonest are developmental delay, motor abnormalities, seizures and EEG abnormalities. In contrast to methylcobalamin defects, MTHFR deficiency is not associated to megaloblastic anaemia [141,152,162].

Deficiency of MTHFR can be confirmed and diagnosed prenatally by direct enzyme assays in skin fibroblasts, leucocytes and lymphocytes using labelled substrates [145]. The clinical heterogeneity of this deficiency has been verified at the biochemical level. Some patients have shown to have a thermolabile form of the enzyme as the cause of mild hyperhomocysteinaemia [165] and in some others with early onset of the disease, severe MTHFR mutations were combined with the common C677T mutation, which is a polymorphism responsible for the majority of enzyme thermolability in the general population [166].

Several different mutations responsible for severe forms of the disease have been described. Mutation analysis in routine diagnosis is limited to the relatively common known mutations otherwise it requires extensive gene

Chapter 2

sequencing. Nevertheless, this type of analysis has been increasing in particular for heterozygotes' detection [145].

Treatment is complicated because most cases are resistant to high doses of vitamin [154,160]. The major goals are reduction of homocysteine levels and elevation of those of methionine. Early treatment with betaine has improved the overall condition [167] by decreasing homocysteine levels, not to the normal range, though [168]. Other therapy agents as folic or folinic acid and several forms of folates have been used to maximize any residual enzymatic activity. Methyl-THF has also been tried, aiming at correcting the product deficiency; pyridoxine (vitamin B₆) with the objective of lowering homocysteine levels; riboflavin for being a requirement of methylene-THF reductase; cobalamin because it is the co-factor of methionine synthase; methionine to correct the cellular deficiency and carnitine since its synthesis requires SAM. Several of these agents have sometimes been used in combination [152].

7. COBALAMIN METABOLISM

The conversion of cobalamin (Cbl or vitamin B₁₂) into its active co-enzyme requires physiological and biochemical processes before binding to the apoenzyme to produce the active holo-enzyme. Therefore, deficient activity of the enzyme can result not only from a defect in the protein itself but also from a defect in the conversion of the vitamin into the co-enzyme. This conversion may be complex and depend on many physiological and biochemical processes such as stomach release of bound vitamin, intestinal uptake, intracellular release, compartmentalization and metabolism [154].

Absorption of dietary free Cbl involves binding to haptocorrin (R-binder or TCI), a glycoprotein that exists in saliva. It is then released in the small intestine by proteolytic hydrolysis, where Cbl binds to intrinsic factor (IF) produced by stomach parietal cells. IF-Cbl complex enters the enterocyte, Cbl binds to transcobalamin II (TCII) and enters the portal bloodstream. All extracellular cobalamin is bound to TCII or to the related glycoprotein haptocorrin binders. When this complex enters the cells, Cbl is released into

the cytoplasm by proteolytic digestion of TCII and is converted into its active forms, i.e. the trivalent cobalt atom is reduced [154,141].

Cobalamin co-enzymes are needed for activity of two reactions in man. One is methylcobalamin (MeCbl)-dependent cytosolic methionine synthase, which converts homocysteine to methionine, and the other is adenosylcobalamin (AdoCbl)-dependent mitochondrial methylmalonyl-CoA mutase, which catalyses the methylmalonyl-CoA conversion to succinyl-CoA, thereby genetic defects of absorption, transport and cellular uptake of cobalamin affect the metabolism of homocysteine and/or methylmalonic acid [169].

These two co-enzymes MeCbl and AdoCbl are formed, after lysosomal release of Cbl, from their precursor hydroxocobalamin by a complex sequence of processes (Figure 7). MeCbl is formed from hydroxocobalamin in the cytoplasm by the catalytic action of methionine synthase which provides an important link between cobalamin and folate metabolism. AdoCbl is formed in the mitochondrion by successive reductions of cobalt ion and transfer of an adenosyl group [169].

Defects of the intracellular processing of these cobalamins are designated on the basis of genetic complementation analysis indicating the site of the genetic defect as following: (a) defects of AdoCbl formation are CblA and CblB and result in methylmalonic aciduria; (b) defects of common steps to both co-enzyme formation are CblC, CblD and CblF; (c) defects of MeCbl synthesis with normal AdoCbl formation, CblE or CblG [152,169].

As some of cobalamin defects lead to homocysteine accumulation and low methionine levels, the SAM/SAH ratio and folate balance become altered affecting transmethylation reactions. The implications with one-carbon metabolism justify the importance of overviewing some of these disorders.

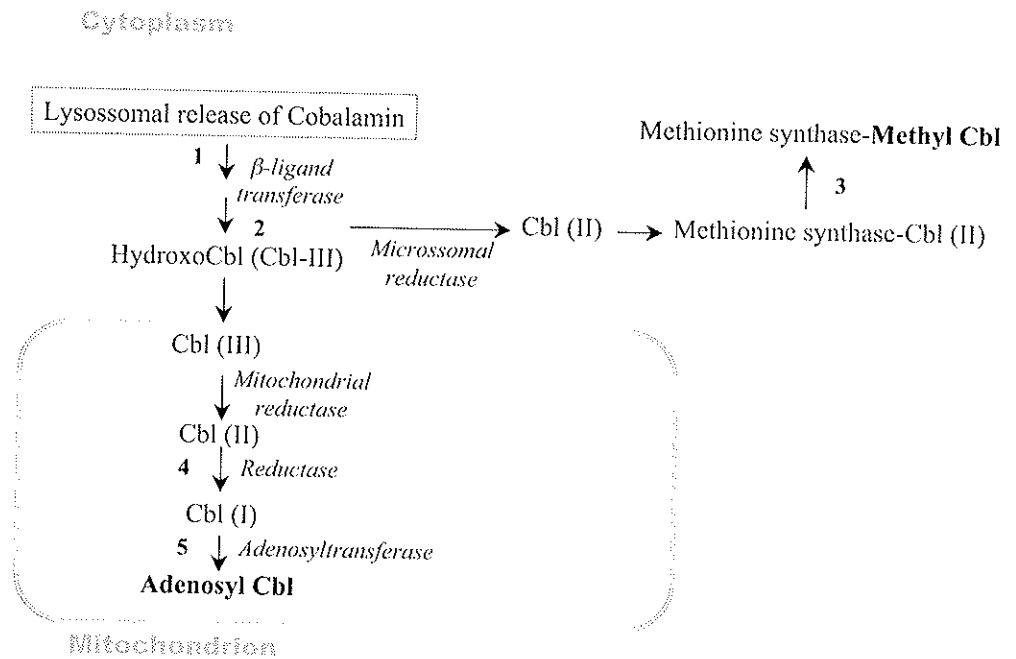

Figure 7 – Main steps of intracellular processing of cobalamins. Adapted from [154].

The sites of genetic defects are indicated as follows: 1. Cbl F; 2. Cbl C/D (exact site not proven); 3. Cbl E/G; 4. Cbl A; 5. Cbl B.

7.1 Absorption and Transport Defects

7.1.1 Intrinsic Factor (IF) Deficiency

It is inherited as an autosomal recessive trait and there is more than one type of IF deficiency. It may result from failure to produce or secrete IF or even from physiological inactivity of the produced protein [152].

This deficiency usually appears between the first and fifth year of age, with symptoms such as failure to thrive, megaloblastic anaemia, irritability and

anorexia [157,158]. Serum levels of cobalamin are markedly low, red blood cell indices are altered, IF is not detected immunologically. In addition, these patients may present homocystinuria and methylmalonic aciduria. Cbl absorption measured by the Schilling test is abnormal in spite of a normal gastric function and morphology [152,156].

Treatment is possible initially with intramuscular hydroxycobalamin until repletion of body stores and afterwards with a periodic dose in order to maintain normal values [156].

No mutations have yet been described although a cDNA has been identified [172].

7.1.2 Selective Vitamin B12 Malabsorption (Imerslund-Gräsbeck Syndrome)

The defect in this disorder seems to be in the IF receptor. Similarly to the IF deficiency patients between the ages of 1 and 5 years old present megaloblastic anaemia, serum Cbl deficiency, normal IF and normal gastrointestinal function [173]. Many of these patients have proteinuria. In contrast with the above mentioned deficiency, Cbl absorption defect is not corrected by supplying it with normal human IF.

Treatment with systemic hydroxycobalamin corrects the anaemia and the neurological findings, but not the proteinuria [156].

The disease gene was identified. An IF-Cbl binding protein, called cubillin, cloned and localized to the same region, was purified from renal proximal tubule. As the mechanism of Cbl transport across the enterocyte is complex, it seems possible that this defect can be localized at different points of this pathway.

7.1.3 Haptocorrin (R-Binder or Transcobalamin) Deficiency

These patients show low serum Cbl levels but no haematological signs of Cbl deficiency. Deficiency or absence of haptocorrin is found in plasma,

saliva and leukocytes [154,170]. No elevation of methylmalonic acid or total homocysteine is observed [154].

Some patients have been diagnosed with neurological findings not attributable to other causes which show that the role of these proteins is still not clear [174].

The haptocorrin gene has been cloned but no mutations have yet been described [156].

7.1.4 Transcobalamin II (TC II) Deficiency

In contrast to the previous diseases of Cbl malabsorption, patients with this deficiency usually develop symptoms in the first few months of life. Nonspecific symptoms such as failure to thrive, weakness, vomiting and diarrhoea have generally been observed. Haematological findings include megaloblastic anaemia, pancytopenia or erythroid hypoplasia. The presence of immature white blood cell precursors and a hypocellular marrow has led to misdiagnosis with leukaemia. Neurological disease may result from inadequate treatment [170,175,176].

Serum cobalamin levels are usually normal reflecting the fact that most serum Cbl is carried by haptocorrin and other R-binders. Cbl bound to TC II is low, as reflected by the unsaturated vitamin B12-binding capacity. Immunologically detectable TC II is generally absent in plasma or is partially detectable but without function. Mild methylmalonic aciduria and homocystinuria have been described with lower levels than in defects in the intracellular metabolism of Cbl co-factors [154,170].

Diagnosis and prenatal diagnosis can be performed by studying TC II synthesis in cultured fibroblasts or amniocytes. The human TC II gene has been mapped and cDNA cloned. DNA testing is, though, possible in families in which the molecular defect has been identified. Several mutations have already been identified [156,176].

7.2 Disorders of Intracellular Cobalamin Metabolism

Defects in the cellular metabolism of Cbl generally result in clinically more severe metabolic disease than absorption and transport defects, mainly because the metabolic disturbances of the first type of defects result from deficient synthesis of both adenosylcobalamin and/or methylcobalamin. As a result, these patients present methylmalonic acidaemia and/or homocystinuria [156].

7.2.1 Functional Methionine Synthase Deficiency (Cobalamin E and G)

Three metabolic pathways intersect at methionine synthase: those of folate, cobalamin and sulphur-containing amino acids. Deficiency of that enzyme results in diminished or absent methylcobalamin synthesis and consequent disorders genetically designated as CblE and CblG complementation groups. That is the reason why the deficiency has been genetically classified as a cobalamin disorder [152,154]. The diseases are both inherited as autosomal recessive traits [152].

Both CblE and CblG are clinically and biochemically very similar. Patients usually show feeding difficulties and lethargy in early childhood. Mental retardation and neurological abnormalities with hypotonia and seizures have been commonly described. Additionally, megaloblastic anaemia, homocystinuria and hypomethioninaemia with normal serum cobalamin and folate concentrations and no methylmalonic aciduria are usual laboratory findings in these deficiencies [169,177,178]. The haematological and neurological problems seem to reflect disturbed DNA synthesis and reduced methylation of neurotransmitters, respectively [152].

At the molecular level, the cblE group seems to have a defect in an enzyme which is required to reduce Cbl so that it can participate in the methionine synthase reaction, or to maintain it in the active reduced form on the enzyme [179]. In contrast, the cblG group is likely to have primary defects of the catalytic subunit of methionine synthase. In this case, the causes of the

Chapter 2

defect seem to be mutations in the gene that encodes for the Cbl-binding domain of the enzyme or for the enzyme abolishing its activity.

Studies in cultured fibroblasts have shown deficient activity of methionine synthase, with reduced incorporation of [^{14}C]methyl-THF. Genetic complementation analysis has distinguished both groups, cblE and cblG [177]. For differential diagnosis of remethylation defects and cobalamin disorders or for complementation analysis, one approach is incubation of cells with labelled formate and measurement of methionine and serine [145].

In patients from both groups, sequence analysis of cDNAs has revealed several different mutations of the gene [180,181]. Diagnosis is based on clinical features, studies on cultured cells and complementation studies. Prenatal diagnosis has been performed for both disorders using amniotic cells.

Treatment has consisted of hydroxycobalamin administration and has been often successful in normalizing haematological and biochemical symptoms but, in general, neurological symptoms have improved more slowly [152,178]. Additional supplementation of folic acid, betaine, methionine, carnitine and pyridoxine has been tried with variable results [152].

7.2.2 Combined Deficiencies of Methylcobalamin and Adenosylcobalamin

Cobalamin F

This group comprises patients with a defect in lysosomal release of cobalamin. As a result, Cbl cannot be converted neither into AdoCbl nor MeCbl. It seems that there is also a lysosomal stage at the enterocyte before release in the portal circulation because these patients have an abnormal Schilling's test [152,156].

About six patients from this group have been reported. The first two cases were girls with stomatitis, glossitis and hypotonia in the first weeks of life. One of them had developmental delay but no haematological abnormalities,

while the second showed macrocytosis and hypersegmented polymorphonuclear neutrophils. Other clinical findings were anaemia, failure to thrive, neurological abnormalities and recurrent infections [154,156,182].

Diagnosis implies enzymatic assays in cultured fibroblasts and complementation analysis distinguishes the mutant class.

Treatment with systemic hydroxycobalamin seems to be effective [156].

Cobalamin C and Cobalamin D

This is the commonest Cbl defect and although its exact mechanism is not proven, the defect seems to be in the reduction of the oxidation state of cobalt (III). Decreased activity of cyanocobalamin β -ligand transferase or microsomal NADH linked cob(III)alamin reductase have been described in fibroblast extracts [183]. As reduction of Cbl does not occur, neither adenosylcobalamin nor methylcobalamin are formed.

Two distinct phenotypes have been recognised based on the age of onset, type of symptoms and outcome after treatment [184]. The early-onset group usually presents feeding difficulties, neurological impairment, ophthalmic and haematological abnormalities and most of these patients die. The late-onset group has a more promising outcome with mild to moderate disability. These patients present in childhood less severe haematological abnormalities and neurological findings include extrapyramidal signs, dementia, psychosis and delirium [184,185]. Manifestation of this disease later in life is rare [186].

Biochemical findings include homocystinuria and methylmalonic acidaemia which are the hallmarks of this disease [184]. Fibroblast studies show decreased synthesis of adenosylcobalamin and methylcobalamin and complementation analysis completes the diagnosis. The molecular basis of the disease has not yet been elucidated [156,184].

Treatment with systemic hydroxycobalamin has been instituted alone or in combination with betaine, carnitine, folic acid and protein restriction diet. There was a decrease of elevated abnormal metabolites but complete

normalization of biochemical parameters and clinical features did not occur in most cases [184-186].

8. CREATINE METABOLISM

Biosynthesis of creatine (α -methyl guanidinoacetic acid) involves two steps (figure 8): the first step, the transfer of an amidino group of arginine to glycine yielding ornithine and guanidinoacetic acid (GAA) catalysed by arginine:glycine amidinotransferase (AGAT) seems to occur in the kidney. The second step is the methylation of guanidinoacetic acid at the amidino group resulting in creatine. This step seems to occur in the liver, the methyl group donor is S-adenosylmethionine, which yields S-adenosylhomocysteine, and the reaction is catalysed by guanidinoacetate methyltransferase (GAMT) [187-191].

Creatine is obtained from the diet, by intestinal absorption and from endogenous synthesis in the kidney, liver and pancreas ($\sim 2\text{g/day}$). It is then transported through the blood and is taken up by creatine requiring tissues, against a concentration gradient, by a Na^+, Cl^- -dependent creatine transporter. High levels of total creatine (creatine and phosphorylcreatine) are found in skeletal muscle, heart, spermatozoa and photoreceptor cells of the retina. Intermediate levels in brain, intestine, seminal vesicles, endothelial cells and macrophages in addition to low levels in lung, kidney, liver, spleen and blood cells [187]. Creatinine is a good indicator of creatine stores in the body as it is produced from creatine and phosphorylcreatine (PCr), by non-enzymatic conversion, at a relatively constant rate. Then, it passively diffuses out of cells to the circulation and is excreted in the urine [188,189].

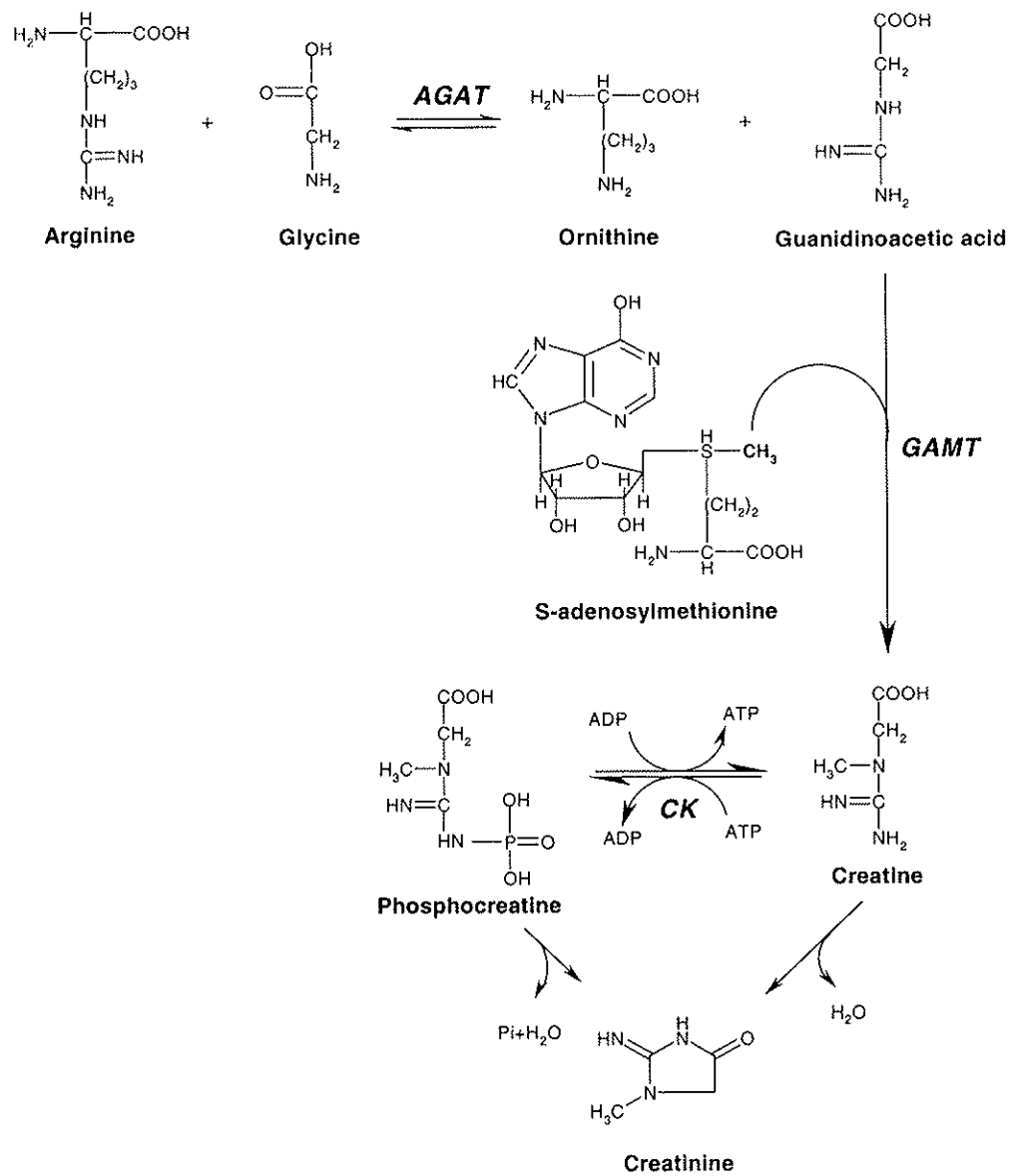

Figure 6 – Pathway of creatine metabolism. Adapted from [188]

AGAT: arginine:glycine amidinotransferase; GAMT: guanidinoacetic acid methyltransferase; CK: creatine kinase.

Chapter 2

Four creatine kinase (CK) isoenzymes are present in higher vertebrates. Muscle cytosolic and sarcomeric isoforms are found in striated muscle, brain cytosolic and ubiquitous isoforms [189]. The CK reaction consists of the transfer of a γ -phosphate group from ATP to creatine yielding ADP and PCr and, on the other hand, at sites of ATP consumption, CK catalyses its regeneration from PCr. Once phosphorylcreatine and creatine are smaller molecules, with higher diffusion coefficients and are present in most CK-containing tissues in higher concentrations than ATP and ADP, the creatine kinase/ phosphorylcreatine/ creatine system increases the total capacity for intracellular high-energy phosphate transport [187,189]. Yet this is a very important phosphate buffering system playing an important role in energy metabolism and transport.

In humans, the daily utilisation of methyl groups for creatine biosynthesis, approximately accounts for 70% of the total labile methyl groups utilised in the body. It roughly corresponds to the daily intake dose of labile methyl groups on a normal, equilibrated diet [187]. It follows that this reaction consumes more methyl groups than all the other reactions combined and that any factor affecting the normal biosynthesis of creatine will presumably alter the methylation status and consequently one-carbon group metabolism. Three creatine deficiency syndromes have been recognised so far. These include GAMT deficiency, the creatine transporter defect and AGAT deficiency [192-194].

8.1 Guanidinoacetate Methyltransferase (GAMT) Deficiency

The first inborn error of creatine metabolism, GAMT deficiency, was discovered in 1994 by Stöckler et al. [195]. It is an autosomal recessive disorder which appears as developmental delay usually during the first months of life with neurological deterioration, speech disability and intractable epilepsy in most cases. Involuntary extrapyramidal movements, muscular hypotonia, autistic-like and self-injurious behaviour were described in some of the reported patients [189,190,196-199].

Biochemical features include decreased concentrations of creatine and accumulation of guanidinoacetic acid in cerebrospinal fluid, plasma and urine. Moreover, the proton magnetic resonance spectroscopy (MRS) of patients' white matter has revealed absence of creatine and PCr, and accumulation of GAA [190,196-199]. Confirmation of the deficiency requires enzyme activity assays and mutation analysis [200,201]. At any rate, treatment with oral creatine supplementation increased the total creatine concentration in the brain and has shown some benefit although none of the patients has improved to a normal level and GAA concentrations have remained elevated [202-204]. On the one hand, combination treatments of creatine supplementation with arginine restriction failed to decrease GAA concentrations [205]. On the other hand, creatine with ornithine supplementation and arginine restriction reduced GAA levels in body fluids and its epileptogenic activity, improving the overall condition even in adult patients [206,207].

8.2 Arginine:Glycine Amidinotransferase (AGAT) Deficiency

AGAT deficiency was recently described [192] in two siblings with mental retardation, severe language impairment and creatine deficiency in the brain presenting extremely low levels of plasma guanidinoacetic acid and of its urinary excretion. AGAT activity was undetectable in cell extracts from these patients and a homozygous mutation was found in both patients by PCR following reverse transcription. The human AGAT gene is localized on chromosome 15q15.3.

A third 5-year-old patient was identified later in the same family [208] with psychomotor and language delay and autistic-like behaviour, showing the same homozygous mutation as both cousins.

Plasma accumulation of glycine and arginine does not seem to occur, as verified by amino acid analysis in the index patients, which means that they are alternatively metabolised [192].

The three patients almost restored low cerebral creatine levels and improved their abnormal development [192,208].

8.3 X-Linked Creatine Transporter Deficiency

Two creatine transporters have been identified and are members of solute-carrier family 6 (neurotransmitter transporters) [209]. The CrT1 gene is expressed in most tissues with highest levels in skeletal muscle and kidney and lower levels in colon, brain, heart, testis and prostate. It has been mapped to chromosome Xq28. The CrT2 is expressed in testis only and has been mapped to chromosome 16p11 [189,194,210].

CrT1 defect is an X-linked disorder. Affected patients presented mild mental retardation, severe speech delay, mild epilepsy and central hypotonia. However, gross and fine motor functions were normal [189,194,210].

Proton magnetic-resonance spectroscopy of the brain has revealed an almost complete absence of the creatine signal in these patients, similar to the one observed in GAMT deficiency. However, unlike in this deficiency, creatine levels were increased in plasma and urine whereas guanidinoacetic acid was normal [194,209,210]. In addition, creatine and phosphocreatine were present in the skeletal muscle suggesting a normal uptake [194]. Confirmation of the diagnosis is possible by studying the creatine uptake in fibroblasts.

One nonsense mutation has been reported until now [194].

Treatment with oral creatine has not shown any clinical improvement [194,209].

9. GLYCINE METABOLISM

Glycine is structurally the simplest of all amino acids. It is easily synthesised from serine and can be converted into glucose via pyruvate being, therefore, glycogenic [211,212]. Glycine is an important constituent of abundant structural proteins like collagen and elastin, constituting a fourth part of their amino acid residues. Formation of glycine conjugates plays an important role in detoxification and it also plays an important synthetic role in creatine and purines metabolism [211,212]. Glycine has a

prominent role in neurotransmission, being predominantly inhibitory in the spinal cord and brain stem and mediating excitatory neurotransmission in the cerebral cortex and other regions of the forebrain [211,213].

The major pathway for the catabolism of glycine and serine is the glycine cleavage system (GCS), in mitochondria. This enzyme complex degrades glycine into a carboxyl and an amino group, and the alpha carbon is transferred to THF, forming 5,10-methylene-THF [211,212,214]. These last compounds participate in the glycine-serine interconversion which is catalysed by serine hydroxymethyltransferase (SHMT). In the fasting state, this reaction is an important source of serine and pyruvate [211,212].

The GCS is a four-component multienzyme complex formed by P-protein (a pyridoxal phosphate-dependent glycine decarboxylase), H-protein (a lipoic-acid containing hydrogen carrier protein), T-protein (a tetrahydrofolate requiring enzyme) and L-protein (lipoamide dehydrogenase) [212,215].

Disorders derived from accumulation of amino acids are rather common, but those associated with low amino acid concentrations have only been described recently. As one patient with glycine deficiency of unknown origin has recently been identified, one can preview the discovery of other disorders of amino acid synthesis in the near future [216].

9.1 Nonketotic Hyperglycinaemia (NKH)

Nonketotic hyperglycinaemia is an autosomal recessive disorder caused by deficient glycine cleavage enzyme complex activity. It is a defect in glycine degradation which results in elevated glycine concentrations. Mildly elevated CSF homocysteine levels have been reported and deficiency in one-carbon metabolites have been suggested once the glycine cleavage reaction through the formation of 5,10-methylene-THF is an important one-carbon donor [211,212,217].

NKH is usually classified in several clinical phenotypes ranging from neonatal to late-onset with several intermediate forms [212]. The clinical features of the commonest type, the neonatal one, appear in the neonatal period or early infancy as rapidly progressing neurological symptoms with

Chapter 2

hypotonia and seizures, feeding difficulties, apnoea, lethargy or coma. Patients frequently show wandering eye movements and intermittent ophthalmoplegia. Death is the usual course of the disease. The survivors show severe mental retardation [211,212,218]. The late-onset type is characterized by patients who have no abnormal signs in the neonatal period and later, during infancy or even adolescence, develop neurological symptoms of various degrees.

Biochemical findings are increased glycine concentrations in plasma, urine and CSF, with no metabolic acidosis, no ketosis and normal organic acids. Diagnosis is usually established by calculating the CSF/plasma glycine ratio which confirms the disease for values higher than 0.08. The accumulation of glycine is due not only to the block in its degradation but also to the overproduction of glycine from serine via serine hydroxymethyltransferase reaction [211,212].

Overall activity of GCS can determine the definitive diagnosis being extremely low or not detectable in the livers or lymphocytes of patients of the neonatal type, while there is usually some residual activity in the late-onset type [219]. The majority of the NKH patients have shown to have a defect in the P-protein and the remaining a defect in the T-protein.

Prenatal diagnosis is possible and has been done, in chorionic villi of placenta, but not in cultured amniotic cells that do not have GCS activity [220].

DNA analysis is also possible. cDNAs encoding P-protein, T-protein and H-protein of the GCS have been cloned and many mutations have been identified [218,221-223].

Several therapeutic approaches have been tried but none of them were appreciably effective. Protein restriction and glycine-free diets reduced glycine in plasma and urine but had no beneficial effect in developmental progress. Benzoate administration to promote conjugation of glycine, forming hippurate, has also been used. Single carbon donors such as methionine, together with a dietary restriction of glycine and serine were tried and leucovorin, folate and/or choline alone or with dietary or pharmacological (benzoate or salicylate) measures but none of them has improved the disease condition [224,225]. Anticonvulsant drugs have also

been tried which led to ambiguous results [226]. Recently, antagonists of the N-methyl-D-aspartate (NMDA) receptor-channel complex, such as ketamine, dextrometorphan and dextrorphan have been tried alone or with benzoate and showed beneficial effects in clinical symptoms of some patients but not much in developmental improvement. New anticonvulsants acting at the NMDA receptors may be useful in the future [227-230].

10. SERINE METABOLISM

L-serine is a conditionally essential amino acid with an important role in cell proliferation as a source of one-carbon units for *de novo* synthesis of purines and dTMP. It is also a precursor of proteins and other amino acids such as cysteine and taurine, of brain serine phospholipids, sphingomyelins and cerebrosides and the neuromodulators glycine and D-serine [217,231].

L-Serine is biosynthesised in the cytosol or it can be derived from glycine by serine hydroxymethyltransferases, present in the cytoplasm and mitochondrion, from protein and phospholipid degradation or dietary intake [231]. The biosynthetic pathway involves the glycolytic intermediate 3-phosphoglycerate, which is converted to phosphohydroxypyruvate, via 3-phosphoglycerate dehydrogenase (3-PGDH). Then, phosphohydroxypyruvate is metabolised by phosphohydroxypyruvate aminotransferase (PHAT) to phosphoserine, which is irreversibly converted into L-serine by phosphoserine phosphatase (PSP) [231,232].

L-serine catabolism via L-serine hydroxymethyltransferases (mSHMT and cSHMT), reversibly forming glycine and generating 5,10-methylenetetrahydrofolate, is the major source of one-carbon groups, which provides formyl groups for purine synthesis and methyl groups for pyrimidine synthesis, remethylation of homocysteine and other methylation reactions involved in cellular homeostasis. This reversible interconversion of L-serine to glycine plays a role in the maintenance of intracellular concentrations of one-carbon groups in the different cellular compartments [231].

Chapter 2

10.1 Disorders of Serine Biosynthesis

Two disorders of serine biosynthesis have been reported so far: 3-phosphoglycerate dehydrogenase deficiency and 3-phosphoserine phosphatase deficiency [231,233]. Another interesting finding was a report from a patient with serine deficiency of unknown cause [234]. This was a 15-year-old girl who had ichthyosis, since her first year of life, progressive polyneuropathy, growth retardation and delayed puberty, with low plasma and CSF serine levels and slightly increased CSF glycine. Notwithstanding, the activities of the three serine biosynthetic enzymes were normal in fibroblasts and as a result, a hyperactivity of serine hydroxymethyltransferase has been hypothesized. The treatment with L-serine greatly improved this condition.

10.1.1 3-Phosphoglycerate Dehydrogenase Deficiency

This disorder has been recently reported by Jaeken et al. [235] in patients with severe neurological symptoms illustrating the importance of serine biosynthesis in brain development and function [231]. These patients show congenital microcephaly, psychomotor retardation, spastic tetraplegia, intractable seizures and megaloblastic anaemia [235,236]. Magnetic resonance imaging of the brain has revealed cortical and subcortical hypotrophy and hypomyelination [237].

Biochemical abnormalities consist of decreased concentrations of serine and glycine in plasma and CSF and low concentration of 5-MTHF in CSF [238]. Neurotransmitter levels have been found normal despite the low CSF folate levels [239].

Thus, the diagnosis can be easily established by analysing fasting plasma and/or CSF amino acids. Confirmation is made by determination of 3-PGDH activity in cultured fibroblasts. Recently, missense mutations have been identified in genetic analysis of patients [232].

Treatment with L-serine alone or combined with glycine has had a beneficial effect [238] and long-term follow-up has shown that early

diagnosis and treatment is associated with a better outcome of the disease [240].

10.1.2 3-Phosphoserine Phosphatase Deficiency

This disorder has been reported in a single patient who also suffered from Williams syndrome [241]. He had decreased serine levels in plasma and CSF, less pronounced than what is usually observed in 3-PGDH deficiency, though. PSP activity was also found to be deficient in fibroblasts. Serine supplementation showed some clinical effect.

11. SARCOSINE AND DIMETHYLGLYCINE METABOLISM

Sarcosine and dimethylglycine are intermediates in one-carbon metabolism (figure 4). Dimethylglycine derives from betaine in the reaction of homocysteine remethylation. Sarcosine (N-methylglycine) is formed by oxidative demethylation of N,N-dimethylglycine catalysed by dimethylglycine dehydrogenase and is subsequently oxidized by sarcosine dehydrogenase through removal of the methyl group to form glycine. These two consecutive oxidative demethylation steps occur in mitochondria and produce one-carbon groups that react with THF to give 5,10-methylene-THF. These active one-carbon groups are preferentially used in the formation of serine [242-245].

11.1 Sarcosinaemia

Sarcosinaemia is a rare inborn error of amino acid metabolism, characterized by increased plasma and urine concentration of sarcosine. It is inherited as an autosomal recessive condition and was first described in 1966 by Gerritsen and Waisman [246] in a child with mental retardation and neurological problems. Since then, additional patients have been described

with mental and/or neurological abnormalities suggesting a cause-effect but a newborn screening programme in Quebec identified many individuals with sarcosinaemia and without clinical manifestations indicating that the disease is a benign one [247].

Sarcosinaemia may be due to more than a single enzyme alteration. It may result from a deficiency in sarcosine dehydrogenase apoenzyme in the electron transfer flavoprotein or even involve a peroxisomal oxidase [242,248]. Sarcosinaemia and sarcosinuria have also been observed in folic acid deficiency [242].

11.2 Dimethylglycine Dehydrogenase (DMGDH) Deficiency

A defect in the conversion of dimethylglycine (DMG) into sarcosine was first described by Moolenaar et al. [244] in an apparently healthy, with normal intelligence, 38 year-old patient, with a history of an abnormal fish odour, unusual muscular fatigue and in whom no abnormalities had been found by conventional metabolic screening techniques. A high excretion of dimethylglycine was observed in the proton nuclear magnetic resonance (^1H NMR) spectrum of the patient's urine which was further confirmed by GC-MS and carbon nuclear magnetic resonance (^{13}C NMR). The concentration of DMG was also increased in the patient's serum and betaine was slightly above the reference interval in urine but not in serum.

It is not possible to detect DMGDH enzymatic activity in human control blood cells or fibroblasts. For this reason, it could not be confirmed in this case. Anyway, analysis of the *DMGDH* gene revealed a homozygous missense mutation in this patient [244].

Dimethylglycinuria and dimethylglycinaemia have also been described in patients with folate deficiency. Mildly increased DMG concentrations have been found in patients with cobalamin deficiency, renal failure and impaired homocysteine metabolism [245,249,250].

12. ANALYTICAL CHEMICAL ASPECTS

The laboratory diagnosis of inborn errors of metabolism requires precise and rapid methods for identification and quantification of accumulating metabolites, biosynthetic intermediates or detection of missing products, in plasma, urine and CSF. Nowadays, a variety of techniques are used from chromatographic methods, which have suffered a great development in the last decades, to enzyme and molecular biology techniques [25,251]. Group screening tests, by means of chromatographic techniques, have shown to be of major importance for the identification of various defects and an important requirement is that novel and better techniques replace the old ones [128,252].

The screening fluid of choice for most disorders is the 24-h urine sample, once it reflects most of the biochemical processes which take place in the human body. For substances not excreted in the urine, the fasting plasma sample is used; for disorders affecting the brain, CSF analysis is sometimes a better approach [128]. Analysis of intracellular metabolic products may also be useful and this is the case of erythrocyte nucleotides in purine and pyrimidine disorders [50,128,251]. The erythrocyte folate content is easier to be measured because it is approximately 40 to 100 fold higher than the serum and it is less dependent on dietary fluctuations [253]. In this case, whole blood is collected in EDTA or lithium-heparin tubes for assay of erythrocyte folates. A sub-sample is then haemolysed using a hypotonic solution and intracellular folate is deconjugated [254].

Diagnosis of amino acid disorders requires the analysis of both plasma and urine. However, mild elevations or decreases will only be detected in fasting plasma. On the contrary, accumulation of amino acids with low renal threshold or in case of renal transport defects, will appear in the urine [255]. As to the biochemical diagnosis of 3-PGDH deficiency, it is based on the detection of low concentrations of serine in fasting plasma and CSF and non-ketotic hyperglycinaemia identification requires CSF analysis [231,255]. Haemolysis or unspun blood species at room temperature can show artefactual changes in several amino acids. To minimize this, samples should be kept cold, centrifugation and separation of plasma or serum

should be done as soon as possible and, if the analysis cannot be promptly done, the sample should be deproteinized and stored frozen. Indeed, in homocysteine analysis, as free homocysteine is lost to protein binding and because there is a time and temperature-dependent release of homocysteine from blood cells causing significant increases in plasma total homocysteine, the indications given above are of extreme importance. Therefore, blood samples must be kept on ice or immediately centrifuged and plasma must be deproteinized within 30 min after collection [147]. Homocysteine values are approximately 10% higher in serum compared to EDTA plasma and storage of plasma or serum causes redistribution of the various oxidized, reduced and protein-bound forms with an increase of the protein-bound fraction [255]. Treatment with a reducing agent like dithioereitol before analysis is a common practice to measure all these forms [145,147].

Another artefact that one must be aware is that low serine in urine may be caused by bacterial contamination [255].

Concerning purine and pyrimidine analysis, venous blood is usually collected in heparin or EDTA and differently from the amino acids it should be stored at room temperature until separation of plasma because there is a smaller increment of plasma purine levels at room temperature [50]. Separation of plasma should be made as rapidly as possible, after blood centrifugation at 1500g. The top fifth cell layer is usually discarded and the remaining erythrocytes are washed twice with isotonic saline buffer for nucleotide or enzyme analysis [50]. These sample preparation steps are fundamental pre-analytical procedures. For purine analysis, the urine should previously be placed in an ultrasonic bath, warmed to 56°C for 30 min, as to dissolve precipitated purines such as xanthine, uric acid, dihydroxyadenine [50,102]. Dietary and drug interference constitute a main problem in purine and pyrimidine analysis and, in order to overcome this difficulty, purification steps using ion-exchange or solid-phase extraction methods have been used prior to HPLC analysis [50,102].

Capillary gas-liquid chromatography / mass spectrometry (GC-MS) techniques are mostly used for organic acids although some pyrimidines can also be detected. Semi-quantitative analysis of trimethylsilylated or methylated derivatives is generally performed in urine after extraction with

organic solvents or anion-exchange methods. For detection of subtle abnormalities, as in transcobalamin II deficiency, improved extraction procedures or stable isotope dilution assays are required [104,256].

GC-MS methods for plasma total homocysteine (free + protein-bound) determination and for quantitative analysis of amino acids have also been described, although HPLC techniques are more common [147,255]. Furthermore, methods using stable isotope dilution and GC-MS have been used for diagnosis of inborn errors of metabolism by analysis and quantification of amino acids, purines, pyrimidines and organic acids [257]. High-performance liquid chromatography methods have been used for analysis of purines, pyrimidines and amino acids. Since purines and their nucleosides are not easily isolated from biological fluids by solvent extraction, they do not have an accessible functional group to react with specific reagents because they have a strong UV-absorbance and differ in their acidic character, reversed-phase HPLC with diode-array detection is the election method for their analysis [50,102,251].

As to amino acids, ion-exchange chromatography and reversed-phase HPLC with fluorescence detection have been the mostly used methods for their quantitative analysis [255]. As a matter of fact, HPLC with derivative formation and fluorescence detection is a high sensitivity method which in mild disturbances measures normal levels of total homocysteine reliably. Electrochemical detection assays have also been used for homocysteine [147].

LC-MS and tandem electrospray MS detection of purines and pyrimidines by multiple reaction monitoring, using a variety of stable isotope-labelled internal standards and specific parent/daughter conversion for each analyte have been used recently, enabling an analysis time of less than 10 minutes [251]. This will certainly become the method of choice in the near future. Reversed-phase LC-MS/MS methods for amino acids are now under development, despite some limitations, by direct analysis of their butyl esters employing stable isotope labelled analogues as internal standards. These methods use plasma, whole blood on filter paper and urine samples, analysis time is of 2 min and fast ion bombardment and electrospray ionization are both applicable [255].

Chapter 2

Tandem mass spectrometry methods have recently been developed with the advantage of being applicable to polar compounds, unlike GC-MS, being precise and much faster. Assays for various groups of selected amino acids, homocysteine, methionine, purines and pyrimidines among others have been developed [258,259]. This versatility has enabled its recent application in newborn screening of inborn errors of metabolism making it one of the most attractive technologies [260].

Proton NMR spectroscopy of body fluids can be a useful complementary technique to be used as a last resort when other common diagnostic techniques do not lead to diagnosis and there is a strong suspicion of some metabolic disease [261]. It shows the majority of proton-containing compounds thereby providing an overall view of metabolism. As it does not require derivatisation or extraction, there is no loss of metabolites. Deproteinization of serum and CSF is required as well as addition of an internal standard. Urine is the fluid of choice but, since urine NMR spectra are very complex, sometimes it is necessary to investigate the plasma or serum or even CSF in diseases affecting the central nervous system [244,250,261].

Dimethylglycine dehydrogenase deficiency is one example of the three novel inborn errors of metabolism diagnosed by *in vitro* NMR spectroscopy [244].

Rapid, widely available automated assays have also been developed for some metabolites. For total plasma homocysteine, simple, routine use, immunological methods using fluorescence polarization immunoassays and enzyme immunoassays have recently been developed [262].

Serum vitamin B₁₂ and serum folate are usually measured by automated competitive displacement assays [253]. However, limitations of serum vitamin B₁₂ and folate measurements have led to the recognition that MMA and homocysteine measurements are most sensitive and specific indicators of functional vitamin B₁₂ deficiency [253].

The overview given above, of purine metabolism and one-carbon unit metabolism, respective pathways and associated disorders, has shown that both are closely linked once the purine synthesis de novo requires carbon units to complete the purine ring.

Nevertheless, the biochemistry of purines has surprisingly shown to be useful in the screening of methylation defects. Our studies have started in search of purines and pyrimidines' defects and led to creatine biosynthesis defects. They are presented and will be discussed in the following chapters.

Chapter 2

REFERENCES

- [1] Cory JG (1997) Purine and pyrimidine nucleotide metabolism. In Thomas M Devlin (Ed): Textbook of Biochemistry with Clinical Correlations. New York: Wiley-Liss Inc, p 489-523.
- [2] Van den Berghe G, Everaerts MC, Corbeel L (1981) Inborn errors of purine catabolism. *Acta Paediatr Belg* **34**: 3-12.
- [3] Stryer L (1995) Biosynthesis of Nucleotides. In: Biochemistry. New York: W H Freeman and Company, p 739-762.
- [4] Fox IH (1974) Purine ribonucleotide catabolism: clinical and biochemical significance. Review. *Nutr Metab* **16**(2): 65-78.
- [5] Becker MA (2001) Hyperuricemia and gout. In Scriver, Beaudet, Valle, Sly (Eds): The Metabolic and Molecular Basis of Inherited Disease. New York: McGraw Hill, p 2513-2535.
- [6] Zalkin H, Dixon JE (1992) De novo purine nucleotide biosynthesis. *Prog Nucleic Acid Res Mol Biol* **42**: 259-287.
- [7] Palella TD, Fox IH (1989) Hyperuricemia and gout. In Scriver, Beaudet, Sly, Valle (Eds): The Metabolic and Molecular Basis of Inherited Disease. New York: McGraw Hill, p 965-1006.
- [8] Becker MA, Raivio KO, Seegmiller JE (1979) Synthesis of phosphoribosylpyrophosphate in mammalian cells. *Adv Enzymol Relat Areas Mol Biol* **49**: 281-306.
- [9] Becker MA, Kim M (1987) Regulation of purine synthesis de novo in human fibroblasts by purine nucleotides and phosphoribosylpyrophosphate. *J Biol Chem* **262**: 14531-14537.
- [10] Hershfield MS, Seegmiller JE (1976) Regulation of de novo purine biosynthesis in human lymphoblasts. *J Biol Chem* **251**: 7348-7354.
- [11] Van der Weyden M, Kelley WN (1974) Human adenylosuccinate synthetase. Partial purification, kinetic and regulatory properties of the enzyme. *J Biol Chem* **249**: 7282-7289.

- [12] Fox IH (1981) Metabolic basis for disorders of purine nucleotide degradation. *Metabolism* **30**: 616-634.
- [13] Krenitsky TA, Elion GB, Henderson AM, Hitchings GH (1968) Inhibition of human purine nucleoside phosphorylase: Studies with intact erythrocytes and the purified enzyme. *J Biol Chem* **243**: 2876-2881.
- [14] Kelley WN, Rosenbloom FM, Henderson JF, Seegmiller JE (1967) Xanthine phosphoribosyltransferase in man: Relationship to hypoxanthine guanine phosphoribosyltransferase. *Biochem Biophys Res Comm* **28**: 340-345.
- [15] Krenitsky TA, Papaioannou R, Elion GB (1969) Human hypoxanthine phosphoribosyltransferase. I Purification, properties, and specificity. *J Biol Chem* **244**: 1263-1270.
- [16] Krenitsky TA, Papaioannou R (1969) Human hypoxanthine phosphoribosyltransferase. II Kinetics and chemical modification. *J Biol Chem* **244**: 1271-1277.
- [17] Andres CM, Fox IH (1979) Purification and properties of human placental adenosine kinase. *J Biol Chem* **254**: 11388-11393.
- [18] Hurley MC, Palella TD, Fox IH (1983) Human placental deoxyadenosine and deoxyguanosine phosphorylating activity. *J Biol Chem* **258**: 15021-15027.
- [19] Holmes EW, Wyngaarden JB, Kelley WN (1973) Human glutamine phosphoribosylpyrophosphate amidotransferase. Two molecular forms interconvertible by purine ribonucleotides and phosphoribosylpyrophosphate. *J Biol Chem* **248**: 6035-6040.
- [20] Itakura M, Sabina RL, Heald PW, Holmes EW (1981) Basis for the control of purine biosynthesis by purine ribonucleotides. *J Clin Invest* **67**: 994-1002.
- [21] Fox IH, Kelley WN (1972) Human phosphoribosylpyrophosphate synthetase. Kinetic mechanism and end-product inhibition. *J Biol Chem* **247**: 2126-2131.
- [22] Fox IH, Kelley WN (1971) Human phosphoribosylpyrophosphate synthetase. Distribution, purification and properties. *J Biol Chem* **246**: 5739-5748.
- [23] Becker MA, Losman MJ, Kim M (1987) Mechanisms of accelerated purine nucleotide synthesis in human fibroblasts with superactive phosphoribosylpyrophosphate synthetases. *J Biol Chem* **262**: 5596-5602.

Chapter 2

- [24] Holmes EW (1980) Kinetic, physical and regulatory properties of amidophosphoribosyltransferase. *Adv Enzyme Regul* **19**: 215-231.
- [25] Dent CE, Philpot GR (1954) Xanthinuria. An inborn error (or deviation) of metabolism. *The Lancet* **1**: 182-185.
- [26] Simmonds HA, Duley JA, Fairbanks LD, McBride MB (1997) When to investigate for purine and pyrimidine disorders. Introduction and review of clinical and laboratory indications. *J Inher Metab Dis* **20**:214-26.
- [27] Dahan K, Fuchshuber A, Adamis S, Smaers M, Kroiss S, Loute G, Cosyns J-P, Hildebrandt F, Verellen-Dumoulin C, Pirson Y (2001) Familial juvenile hyperuricemic nephropathy and autosomal dominant medullary cystic kidney disease type 2: Two facets of the same disease? *J Am Soc Nephrol* **12**: 2348-2357.
- [28] Simmonds HA, Van Gennip AH (2002) Purine and pyrimidine disorders. In: *Physician's Guide to the Laboratory Diagnosis of Metabolic Diseases*. Berlin: Springer-Verlag, p 445-466.
- [29] Sperling O, Eilam G, Persky-Brosh S, de Vries A (1972) Accelerated erythrocyte 5-phosphoribosyl-1-pyrophosphate synthesis. A familial abnormality associated with excessive uric acid production and gout. *Biochem Med* **6**: 310-316.
- [30] Sperling O, Persky-Brosh S, Boer P, de Vries A (1973) Human erythrocyte phosphoribosylpyrophosphate synthetase mutationally altered in regulatory properties. *Biochem Med* **7**: 389-395.
- [31] Zoref E, de Vries A, Sperling O (1975) Mutant feedback-resistant phosphoribosylpyrophosphate synthetase associated with purine overproduction and gout. Phosphoribosylpyrophosphate and purine metabolism in cultured fibroblasts. *J Clin Invest* **56**: 1093-1099.
- [32] Becker MA, Smith PR, Taylor W, Mustafi R, Switzer RL (1995) The genetic and functional basis of purine nucleotide feedback-resistant phosphoribosylpyrophosphate synthetase superactivity. *J Clin Invest* **96**:2133-2141.
- [33] Becker MA, Puig JG, Mateos FA, Jimenez ML, Kim M, Simmonds HA (1988) Inherited superactivity of phosphoribosylpyrophosphate synthetase:

- Association of uric acid overproduction and sensorineural deafness. *Am J Med* **85**: 383-390.
- [34] Ahmed M, Taylor W, Smith PR, Becker MA (1999) Accelerated transcription of PRPS1 in X-linked overactivity of normal human phosphoribosylpyrophosphate synthetase. *J Biol Chem* **274**:7482-7488.
- [35] Jinnah HA, Friedmann T (2001) Lesch-Nyhan disease and its variants. In Scriver, Beaudet, Valle, Sly (Eds): *The Metabolic and Molecular Basis of Inherited Disease*. New York: McGraw Hill, p 2537-2570.
- [36] Nyhan WL (1997) The recognition of Lesch-Nyhan syndrome as an inborn error of purine metabolism. *J Inher Metab Dis* **20**: 171-178.
- [37] Lesch M, Nyhan WL (1964) A familial disorder of uric acid metabolism and central nervous system function. *Am J Med* **36**:561-570.
- [38] Seegmiller JE, Rosenbloom FM, Kelley WN (1967) Enzyme defect associated with a sex-linked human neurological disorder and excessive purine synthesis. *Science* **155**: 1682-1684.
- [39] Augoustides-Savvopoulou P, Papachristou F, Fairbanks LD, Dimitrakopoulos K, Marinaki AM, Simmonds HA (2002) Partial hypoxanthine-guanine phosphoribosyltransferase deficiency as the unsuspected cause of renal disease spanning three generations: A cautionary tale. *Pediatrics* **109**(1): 1-4.
- [40] Stout JT, Caskey CT (1989) Hypoxanthine phosphoribosyltransferase deficiency: The Lesch-Nyhan syndrome and gouty arthritis. In Scriver, Beaudet, Sly, Valle (Eds): *The Metabolic and Molecular Basis of Inherited Disease*. New York: McGraw Hill, p 1007-1028.
- [41] Van der Zee SPM, Schretlen E, Monnens L (1968) Megaloblastic anemia in the Lesch-Nyhan syndrome. *Lancet* **1**: 1427.
- [42] De Gregorio L, Nyhan WL, Serafin E, Chamoles NA (2000) An unexpected affected female patient in a classical Lesch-Nyhan family. *Mol Genet Metab* **69**: 263-268.
- [43] Jolly DJ, Okayama H, Berg P, Esty AC, Filpula D, Bohlen P, Johnson GG, Shively JE, Hunkapillar T, Friedmann T (1983) Isolation and characterization of a full length, expressible cDNA for human hypoxanthine guanine phosphoribosyl transferase. *Proc Natl Acad Sci USA* **80**:477-481.

Chapter 2

- [44] Jinnah HA, De Gregorio L, Harris JC, Nyhan WL, O'Neill JP (2000) The spectrum of inherited mutations causing HPRT deficiency: 75 new cases and a review of 196 previously reported cases. *Mutat Res* **463**: 309-326.
- [45] Rossiter BJB, Caskey CT (1995) Hypoxanthine-guanine phosphoribosyltransferase deficiency: Lesch-Nyhan syndrome and gout. In Scriver, Beaudet, Sly, Valle (Eds): *The Metabolic and Molecular Basis of Inherited Disease*. New York: McGraw Hill, p1679-1706.
- [46] Sahota AS, Tischfield JA, Kamatani N, Simmonds HA (2001) Adenine phosphoribosyltransferase deficiency and 2,8-dihydroxyadenine lithiasis. In Scriver, Beaudet, Valle, Sly (Eds): *The Metabolic and Molecular Basis of Inherited Disease*. New York: McGraw Hill, p 2571-2584.
- [47] Simmonds HA, Sahota AS, Van Acker KJ (1995) Adenine phosphoribosyltransferase deficiency and 2,8-dihydroxyadenine lithiasis. In Scriver, Beaudet, Sly, Valle (Eds): *The Metabolic and Molecular Basis of Inherited Disease*. New York: McGraw Hill, p1707-1724.
- [48] Benedetto B, Madden R, Kurbanov A, Braden G, Freeman J, Lipkowitz GS (2001) Adenine phosphoribosyltransferase deficiency and renal allograft dysfunction. *Am J Kidney Dis* **37**: E37.
- [49] Bye S, Mallmann R, Duley J, Simmonds HA, Chen J, Tischfield JA, Sahota A (1994) Identification of a 7-basepair deletion in the adenine phosphoribosyltransferase gene as a cause of 2,8-dihydroxyadenine urolithiasis. *J Clin Invest* **72**: 550-553.
- [50] Simmonds HA, Duley JA, Davies PM (1991) Analysis of Purines and Pyrimidines in Blood, Urine, and Other Physiological Fluids. In Hommes F (Ed): *Techniques in Diagnostic Human Biochemical Genetics: A Laboratory Manual*. New York: Wiley-Liss, p 397-424.
- [51] Van Gennip AH, Van Noordenburg-Huistra DY, De Bree PK, Wadman SK (1978) Two-dimensional thin-layer chromatography for the screening of disorders of purine and pyrimidine metabolism. *Clin Chim Acta* **86**: 7-20.
- [52] Edvardsson V, Palsson R, Olafsson I, Hjaltadottir G, Laxdal T (2001) Clinical features and genotype of adenine phosphoribosyltransferase deficiency in Iceland. *Am J Kidney Dis* **38**: 473-480.

- [53] Hershfield MS, Mitchell BS (2001) Immunodeficiency diseases caused by adenosine deaminase deficiency and purine nucleoside phosphorylase deficiency. In Scriver, Beaudet, Valle, Sly (Eds): *The Metabolic and Molecular Basis of Inherited Disease*. New York: McGraw Hill, p 2571-2584.
- [54] Gibblet ER, Anderson JE, Cohen F, Pollara B, Meuwissen HJ (1972) Adenosine deaminase deficiency in two patients with severely impaired cellular immunity. *Lancet* **2**: 1067-1069.
- [55] Hirschhorn R (1993) Overview of biochemical abnormalities and molecular genetics of adenosine deaminase deficiency. *Pediatr Res* **33**(Suppl): S35-S41.
- [56] Bollinger ME, Arredondo-Vega FX, Santisteban I, Schwarz K, Hershfield MS, Lederman HM (1996) Hepatic dysfunction as a complication of adenosine deaminase deficiency. *N Engl J Med* **334**: 1367-1371.
- [57] Hirschhorn R, Yang DR, Puck JM, Huie ML, Jinang CK, Kurlandsly LE (1996) Spontaneous in vivo reversion to normal of an inherited mutation in a patient with adenosine deaminase deficiency. *Nature Genet* **13**: 290-295.
- [58] Cohen A, Hirschhorn R, Horowitz SD, Rubinstein A, Polmar SH, Hong R, Martin DW Jr (1978) Deoxyadenosine triphosphate as a potentially toxic metabolite in adenosine deaminase deficiency. *Proc Natl Acad Sci USA* **75**: 472-475.
- [59] Hershfield MS (1979) Apparent suicide inactivation of human lymphoblast S-adenosylhomocysteine hydrolase by 2'-deoxyadenosine and adenine arabinoside. A basis for direct toxic effects of analogs of adenosine. *J Biol Chem* **254**: 22-25.
- [60] Hershfield MS, Arredondo-Vega FX, Santisteban I (1997) Clinical expression, genetics and therapy of adenosine deaminase (ADA) deficiency. *J Inher Metab Dis* **20**: 179-185.
- [61] Seto S, Carrera CJ, Kubota M, Wasson DB, Carson DA (1985) Mechanism of deoxyadenosine and 2-chlorodeoxyadenosine toxicity to nondividing human lymphocytes. *J Clin Invest* **75**: 377-383.
- [62] Kizaki H, Suzuki K, Tadakuma T, Ishimura Y (1990) Adenosine receptor-mediated accumulation of cyclic AMP-induced T-lymphocyte death through internucleosomal DNA cleavage. *J Biol Chem* **265**: 5280-5284.

Chapter 2

- [63] Gibblet ER, Ammann AJ, Wara DW, Sandman R, Diamond LK (1975) Nucleoside phosphorilase deficiency in a child with severely defective T-cell immunity and normal B-cell immunity. *Lancet* **1**: 1010-1013.
- [64] Van den Berghe G, Vincent M-F, Marie S (2000) Disorders of purine and pyrimidine metabolism. In Fernandes J, Saudubray J-M, van den Berghe G (Eds): *Inborn Metabolic Diseases-Diagnosis and Treatment*. Berlin: Springer-Verlag, p 353-368.
- [65] Stoop JW, Zegers BMJ, Hendrek GFM, Siegenbeek van Heulelom LH, Staal GEJ, de Bree PK, Wadman SK, Ballieux RE (1977) Purine nucleoside phosphorylase deficiency associated with selective cellular immunodeficiency. *N Engl J Med* **296**: 651-655.
- [66] Cohen A, Gudas LJ, Ammann AJ, Stall GEJ, Martim DW (1978) Deoxyguanosine triphosphate as a possible toxic metabolite in the immunodeficiency associated with purine nucleoside phosphorylase deficiency. *J Clin Invest* **61**: 1405-1409.
- [67] Markert ML, Finkel BD, McLaughlin TM, Watson TJ, Collard HR, McMahon CP, Andrews LG, Barrett MJ, Ward FE (1997) Mutations in purine nucleoside phosphorylase deficiency. *Hum Mutat* **9**: 118-121.
- [68] Fishbein WN, Armbrustmacher VW, Griffin JL (1978) Myoadenilate deaminase deficiency: a new disease of muscle. *Science* **200**: 545-548.
- [69] Gross M (1997) Clinical heterogeneity and molecular mechanisms in inborn muscle AMP deaminase deficiency. *J Inher Metab Dis* **20**: 186-192.
- [70] Van den Berghe G, Bontemps F, Vincent MF, Van den Bergh F (1992) The purine nucleotide cycle and its molecular defects. *Prog Neurobiol* **39**: 547-561.
- [71] Sabina RL, Fishbein WN, Pezeshkpour G, Clarke PR, Holmes EW (1992) Molecular analysis of the myoadenilate deaminase deficiencies. *Neurology* **42**: 170-179.
- [72] Sabina RL, Holmes EW (2001) Myoadenylate deaminase deficiency. In Scriver, Beaudet, Valle, Sly (Eds): *The Metabolic and Molecular Basis of Inherited Disease*. New York: McGraw Hill, p 2627-2638.

- [73] Verzijl HTFM, van Engelen BGM, Luyten JAFM, Steenberg GCH, van den Heuvel LPWJ, ter Laak HJ, Padberg GW, Wevers RA (1998) Genetic characteristics of myoadenylate deaminase deficiency. *Ann Neurol* **44**: 140-143.
- [74] Van den Berghe G, Bontemps F, Vincent MF (1991) Purine nucleotide cycle, molecular defects and therapy. In Harkness et al. (Eds): *Purine and Pyrimidine Metabolism in Man VII*, Part B, Plenum Press p 281-286.
- [75] Morisaki T, Gross M, Morisaki H, Pongratz D, Zöllner N, Holmes EW (1992) Molecular basis of AMP deaminase deficiency in skeletal muscle. *Proc Natl Acad Sci USA* **89**: 6457-6461.
- [76] Mahnke-Zizelman DK, Tullson PC, Sabina RL (1998) Novel aspects of tetramer assembly and N-terminal domain structure and function are revealed by recombinant expression of human AMP deaminase isoforms. *J Biol Chem* **273**(52): 35118-35125.
- [77] Gross M, Rotzer E, Kolle P, Mortier W, Reichmann H, Goebel HH, Lochmuller H, Pongratz D, Mahnke-Zizelman DK, Sabina RL (2002) A G468-T AMPDI mutant allele contributes to the high incidence of myoadenylate deaminase deficiency in the Caucasian population. *Neuromuscul Disord* **12**(6): 558-565.
- [78] Patten BM (1982) Beneficial effect of D-ribose in patient with myoadenylate deaminase deficiency. *Lancet* **1**: 1071.
- [79] Lecky BRF (1983) Failure of D-ribose in myoadenylate deaminase deficiency. *Lancet* **1**: 193.
- [80] Raivio KO, Saksela M, Lapatto R (2001) Xanthine oxidoreductase- Role in human pathophysiology and in hereditary xanthinuria. In Scriver, Beaudet, Valle, Sly (Eds): *The Metabolic and Molecular Basis of Inherited Disease*. New York: McGraw Hill, p 2639-2652.
- [81] Simmonds HA, Levin B, Cameron JS (1974) Variations in allopurinol metabolism by xanthinuric subjects. *Clin Sci Mol Med* **47**: 173-178.
- [82] Coughlan MP (1983) The role of molybdenum in human biology. *J Inher Metab Dis* **6**: 70-77.

Chapter 2

- [83] Duran M, Beemer FA, van der Heiden C, Korteland J, de Bree PK, Brink M, Wadman SK, Lombeck I (1978) Combined deficiency of xanthine oxidase and sulphite oxidase: A defect of molybdenum metabolism or transport? *J Inher Metab Dis* **1**: 175-178.
- [84] Johnson JL, Duran M (2001) Molybdenum cofactor deficiency and isolated sulfite oxidase deficiency. In Scriver, Beaudet, Valle, Sly (Eds): *The Metabolic and Molecular Basis of Inherited Disease*. New York: McGraw Hill, p 3163-3177.
- [85] Mize C, Johnson JL, Rajagopalan KV (1995) Defective molybdopterin biosynthesis: clinical heterogeneity associated with molybdenum cofactor deficiency. *J Inher Metab Dis* **18**: 283-290.
- [86] Krenitsky TA, Spector T, Hall WW (1986) Xanthine oxidase from human liver: Purification and characterization. *Arch Biochem Biophys* **247**: 108-119.
- [87] Spector T, Hall WW, Krenitsky TA (1986) Human and bovine xanthine oxidases: Inhibition studies with oxypurinol. *Biochem Pharmacol* **35**: 3109-3114.
- [88] Mateos FA, Puig JG, Jimenez ML, Fox IH (1987) Hereditary xanthinuria: Evidence for enhanced hypoxanthine salvage. *J Clin Invest* **79**: 847-852.
- [89] Bory C, Chantin C, Boulieu R (1996) Comparison of capillary electrophoretic and liquid chromatographic determination of hypoxanthine and xanthine for the diagnosis of xanthinuria. *J Chromatogr A* **730**: 329-331.
- [90] Johnson JL, Rajagopalan KV (1995) An HPLC assay for detection of elevated urinary S-sulphocysteine, a metabolic marker of sulphite oxidase deficiency. *J Inher Metab Dis* **18**: 40-47.
- [91] Parker R, Snedden W, Watts RW (1970) The quantitative determination of hypoxanthine and xanthine ("oxypurines") in skeletal muscle from two patients with congenital xanthine oxidase deficiency (xanthinuria). *Biochem J* **116**: 317-318.
- [92] Bradbury MS, Henderson M, Brocklebank JT, Simmonds HA (1995) Acute renal failure due to xanthine stones. *Pediatr Nephrol* **9**: 476-477.

- [93] Jaeken J, Van den Berghe G (1984) An infantile autistic syndrome characterized by the presence of succinylpurines in body fluids. *Lancet* **2**: 1048-1061.
- [94] Van den Berghe G, Jaeken J (2001) Adenylosuccinate lyase deficiency. In Scriver, Beaudet, Valle, Sly (Eds): *The Metabolic and Molecular Basis of Inherited Disease*. New York: McGraw Hill, p 2653-2662.
- [95] Jaeken J, Wadman SK, Duran M, van Sprang FJ, Beemer FA, Holl RA, Theunissen PM, de Cock P, van den Bergh F, Vincent MF, Van den Berghe G (1988) Adenylosuccinase deficiency: an inborn error of purine nucleotide synthesis. *Eur J Pediatr* **148**: 126-131.
- [96] Van den Bergh FAJTM, Bosschaart AN, Hageman G, Duran M, Poll-The BT (1998) Adenylosuccinase deficiency with neonatal onset severe epileptic seizures and sudden death. *Neuropediatrics* **29**: 51-53.
- [97] Van den Berghe G, Vincent MF, Jaeken J (1997) Inborn errors of the purine nucleotide cycle: Adenylosuccinase deficiency. *J Inher Metab Dis* **20**: 193-202.
- [98] Jaeken J, van den Bergh F, Vincent MF, Casaer P, Van den Berghe G (1992) Adenylosuccinase deficiency: a newly recognized variant. *J Inher Metab Dis* **16**: 416-418.
- [99] Valik D, Miner PT, Jones JD (1997) First US case of adenylosuccinate lyase deficiency with severe hypotonia. *Pediatr Neurol* **16**: 252-255.
- [100] De Bree PK, Wadman SK, Duran M, Fabery de Jonge H (1986) Diagnosis of inherited adenylosuccinase deficiency by thin-layer chromatography of urinary imidazoles and by automated cation exchange column chromatography of purines. *Clin Chim Acta* **156**: 279-288.
- [101] Gross M, Gathof BS, Kölle P, Gresser U (1995) Capillary electrophoresis for screening of adenylosuccinate lyase deficiency. *Electrophoresis* **16**: 1927-1929.
- [102] Duran M, Dorland L, Meuleman EEE, Allers P, Berger R. (1997) Inherited defects of purine and pyrimidine metabolism: Laboratory methods for diagnosis. *J Inher Metab Dis* **20**: 227-236.

Chapter 2

- [103] Salerno C, D'Eufemia P, Finocchiaro R et al (1999) Effect of D-ribose on purine synthesis and neurological symptoms in a patient with adenylosuccinase deficiency. *Biochim Biophys Acta* **1453**: 135-140.
- [104] Oded Sperling (2001) Hereditary Renal Hypouricemia. In: Scriver, Beaudet, Valle, Sly (Eds). *The Metabolic and Molecular Basis of Inherited Disease*. New York: McGraw Hill, p 5069-5083.
- [105] Levy HL (2001) Hartnup Disorder. In: Scriver, Beaudet, Valle, Sly (Eds). *The Metabolic and Molecular Basis of Inherited Disease*. New York: McGraw Hill, p 4957-4969.
- [106] Wilcox WD (1996) Abnormal serum uric acid levels in children. *J Pediatr* **128**(6): 731-741.
- [107] Greene ML, Marcus R, Aurbach GD, Kazam ES, Seegmiller JH (1972) Hypouricemia due to isolated renal tubular defect. Dalmatian dog mutation in man. *Am J Med* **53**: 361-367.
- [108] Meisel AD, Diamond HS (1977) Hyperuricosuria in the Fanconi syndrome. *Am J Med Sci* **273**: 109-115.
- [109] Diamond HS, Paolino JS (1973) Evidence for a post-secretory reabsorptive site for uric acid in man. *J Clin Invest* **52**: 1491-1499.
- [110] Friedman AL, Trygstad CW, Chesney RW (1978) Autosomal dominant Fanconi syndrome with early renal failure. *Am J Med Genet* **2**: 225-232.
- [111] Brenton DP, Isenberg DA, Cusworth DC, Garrod P, Krywawych S, Stamp TCB (1981) The adult presenting idiopathic Fanconi syndrome. *J Inher Metab Dis* **4**: 211-215.
- [112] Schneider JA, Wong V, Seegmiller JE (1969) The early diagnosis of cystinosis. *J Pediatr* **74**: 114-116.
- [113] Morris RC Jr (1968) An experimental renal acidification defect in patients with hereditary fructose intolerance. I. Its resemblance to renal tubular acidosis. *J Clin Invest* **47**: 1389-1398.
- [114] Morris RC Jr (1968) An experimental renal acidification defect in patients with hereditary fructose intolerance. II. Its distinction from classical renal tubular acidosis; its resemblance to the renal acidification defect associated

- with Fanconi syndrome of children with cystinosis. *J Clin Invest* **47**: 1648-1663.
- [115] Garty R, Cooper M, Tabachnik E (1974) The Fanconi syndrome associated with hepatic glycogenosis and abnormal metabolism of galactose. *J Pediatr* **85**: 821-823.
- [116] Izzedine H, Launay-Vacher V, Isnard-Bagnis C, Deray G (2003) Drug-induced Fanconi's syndrome. *Am J Kidney Dis* **41**(2): 292-309.
- [117] Kalatzis V, Antignac C (2003) New aspects of the pathogenesis of cystinosis. *Pediatr Nephrol* **18**(3): 207-215.
- [118] Kerjaschki D, Noronha-Blod L, Sacktor B, Farquhar MG (1984) Microdomains of distinctive glycoprotein composition in the kidney proximal tubule brush border. *J Cell Biol* **98**:1505-1513.
- [119] Rodman JS, Seidman L, Farquhar MG (1986) The membrane composition of coated pits, microvilli, endosomes, and lysosomes is distinctive in the rat kidney proximal tubule cell. *J Cell Biol* **102**: 77-87.
- [120] Coor C, Salmon RF, Quigley R, Marver D, Baum M (1991) Role of adenosine triphosphate (ATP) and Na, K-ATPase in the inhibition of proximal tubule transport with intracellular cysteine loading. *J Clin Invest* **87**: 955-961.
- [121] Cutillas PR, Norden AG, Cramer R, Burlingame AL, Unwin RJ (2003) Detection and analysis of urinary peptides by on-line liquid chromatography and mass spectrometry: application to patients with renal Fanconi syndrome. *Clin Sci* **104**: 483-490.
- [122] Feigenbaum A (2002) Answers to missing mtDNA found at last. *Pediatr Res* **52**(3): 319-320.
- [123] Mandel H, Raymonde S, Labay V, Elpeleg O, Saada A, Shalata A, Anbinder Y, Berkowitz D, Hartman C, Barak M, Eriksson S, Cohen N (2001) The deoxyguanosine kinase gene is mutated in individuals with depleted hepatocerebral mitochondrial DNA. *Nature Genetics* **29**(3): 337-341.
- [124] Taanman J-W, Kateeb I, Muntau AC, Jaksch M, Cohen N, Mandel H (2002) A novel mutation in the deoxyguanosine kinase gene causing depletion of mitochondrial DNA. *Ann Neurol* **52**: 237-239.

Chapter 2

- [125] Salviati L, Sacconi S, Mancuso M, Otaegui D, Camaño P, Marina A, Rabinowitz S, Shiffman R, Thompson K, Wilson C, Feigenbaum A, Naini AB, Hirano M, Bonilla E, DiMauro S, Vu TH (2002) Mitochondrial DNA depletion and dGK gene mutations. *Ann Neurol* **52**: 311-316.
- [126] Carozzo R, Bornstein B, Luciola S, Campos Y, de la Pena P, Petit N, Dionisi-Vici C, Vilarinho L, Rizza T, Bertini E, Garesse R, Santorelli FM, Arenas J (2003) Mutation analysis in 16 patients with mtDNA depletion. *Hum Mutat* **21**(4): 453-454.
- [127] Elpeleg O, Mandel H, Saada A (2002) Depletion of the other genome-mitochondrial DNA depletion syndromes in humans. *J Mol Med* **80**: 389-396.
- [128] Duran M, Dorland L, Wadman SK, Berger R (1994) Group tests for selective screening of inborn errors of metabolism. *Eur J Pediatr* **153**(1): S27-S32.
- [129] Esmans EL, Broes D, Hoes I, Lemièrre F, Vanhoutte K (1998) Liquid chromatography-mass spectrometry in nucleoside, nucleotide and modified nucleotide characterization. *J Chromat A* **794**: 109-127.
- [130] Ito T, Van Kuilenburg ABP, Bootsma A, Haasnoot AJ, Van Cruchten A, Wada Y, Van Gennip AH (2000) Rapid screening of high-risk patients for disorders of purine and pyrimidine metabolism using HPLC-electrospray tandem mass spectrometry of liquid urine or urine-soaked filter paper strips. *Clin Chem* **46** (4): 445-452.
- [131] Adam T, Fairbanks LD, Cevcic J, Bartack P (1999) Capillary electrophoresis for detection of inherited disorders of purine and pyrimidine metabolism. *Clin Chem* **45**: 2086-2093.
- [132] Adam T, Lochman P, Friedeck D (2002) Screening method for inherited disorders of purine and pyrimidine metabolism by capillary electrophoresis with reversed electroosmotic flow. *J Chromat B* **767**: 330-340.
- [133] Wevers RA, Engelke U, Rotteveel JJ, Heerschap A, De Jong JG, Abeling NG, van Gennip AH, de Abreu RA (1997) ¹H-NMR spectroscopy of body fluids in patients with inborn errors of purine and pyrimidine metabolism. *J Inher Metab Dis* **20**(3): 345-350.
- [134] Stryer L (1995) Biosynthesis of Amino acids and Heme. In: Biochemistry. New York: W H Freeman and Company, p 713-738.

- [135] Van den Veyver IB (2002) Genetic Effects of Methylation Diets. *Annu Rev Nutr* **22**: 255-282.
- [136] Appling DR (1991) Compartmentation of folate-mediated one-carbon metabolism in eukariotes. *FASEB J* **5**(12): 2645-2651.
- [137] Mudd SH, Levy HL, Kraus JP (2001) Disorders of Transsulfuration. In Scriver, Beaudet, Valle, Sly (Eds): *The Metabolic and Molecular Basis of Inherited Disease*. New York: McGraw Hill, p 2007-2056.
- [138] Fowler B (1997) Disorders of homocysteine metabolism. *J Inher Metab Dis* **20**: 270-285.
- [139] Rowe PB (1989) Inherited disorders of folate metabolism. In Scriver, Beaudet, Sly, Valle (Eds): *The Metabolic and Molecular Basis of Inherited Disease*. New York: McGraw Hill, p 498-521.
- [140] Andria G, Fowler B, Sebastio G (2000) Disorders of sulfur amino acid metabolism. In Fernandes J, Saudubray J-M, van den Berghe G (Eds): *Inborn Metabolic Diseases-Diagnosis and Treatment*. Berlin: Springer-Verlag, p 284-298.
- [141] Perry TL (1981) Mild elevations of plasma ornithine in homocystinuria. *Clin Chim Acta* **117**: 97-101.
- [142] Dudman NP, Wilcken DE (1983) Increased plasma copper in patients with homocystinuria due to cystathionine beta-synthase deficiency. *Clin Chim Acta* **127**: 105-113.
- [143] Surtees R, Bowron A, Leonard J (1997) Cerebrospinal fluid and plasma total homocysteine and related metabolites in children with cystathionine beta-synthase deficiency: the effect of treatment. *Pediatr Res* **42**: 577-582.
- [144] Dudman NP, Tyrrell PA, Wilcken DE (1987) Homocysteinemia: depressed plasma serine levels. *Metabolism* **36**: 198-201.
- [145] Fowler B, Jakobs C (1998) Post- and prenatal diagnostic methods for the homocystinurias. *Eur J Pediatr* **157**(2): S88-S93.
- [146] Mudd SH, Skovby F, Levy HL, Pettigrew KD, Wilcken B, Pyeritz RE, Andria G, Boers GH, Bromberg IL, Cerone R, et al. (1985) The natural

Chapter 2

- history of homocystinuria due to cystathionine β -synthase deficiency. *Am J Hum Genet* **37**: 1-31.
- [147] Refsum H, Fiskerstrand T, Guttormsen AB, Ueland PM (1997) Assessment of homocysteine status. *J Inher Metab Dis* **20**: 286-294.
- [148] Fowler B, Kraus J, Packman S, Rosenberg LE (1978) Homocystinuria: evidence for three distinct classes of cystathionine β -synthase mutants in cultured fibroblasts. *J Clin Invest* **61**: 645-653.
- [149] Boers GH, Fowler B, Smals AG, Trijbels FJ, Leermakers AI, Kleijer WJ, Kloppenborg PW (1985) Improved identification of heterozygotes for homocystinuria due to cystathionine β -synthase deficiency by the combination of methionine loading and enzyme determination in cultured fibroblasts. *Hum Genet* **69**: 164-169.
- [150] Fowler B (1985) Recent advances in the mechanism of pyridoxine-responsive disorders. *J Inher Metab Dis* **8**(1): 76-83.
- [151] Wilcken B, Turner B (1973) Homocystinuria: Reduced folate levels during pyridoxine treatment. *Arch Dis Child* **48**: 58-62.
- [152] Rosenblatt DS, Fenton WA (2001) Inherited disorders of folate and cobalamin transport and metabolism. In Scriver, Beaudet, Valle, Sly (Eds): *The Metabolic and Molecular Basis of Inherited Disease*, McGraw Hill, New York, p 3897-3933.
- [153] Said HM, Nguyen TT, Dyer DL, Cowan KH, Rubin SA (1996) Intestinal folate transport: identification of a cDNA involved in folate transport and the functional expression and distribution of its mRNA. *Biochim Biophys Acta Biomembranes* **1281**: 164-172.
- [154] Fowler B (1998) Genetic defects of folate and cobalamin metabolism. *Eur J Pediatr* **157**(2): S60-S66.
- [155] Branda RF, Moldow CF, Macarthur JR, Wintrobe MM, Anthony BK, Jacobs HS (1978) Folate-induced remission in aplastic anemia with familial defect of cellular folate uptake. *N Engl J Med* **298**: 469-475.
- [156] Rosenblatt DS (2000) Disorders of cobalamin and folate transport and metabolism. In Fernandes J, Saudubray J-M, van den Berghe G (Eds): *Inborn*

Metabolic Diseases-Diagnosis and Treatment. Berlin: Springer-Verlag, p 284-298.

- [157] Duran M, Ketting D, de Bree PK, van Sprang FJ, Wadman SK, Penders TJ, Wilms RH (1981) A case of formiminoglutamic aciduria. Clinical and biochemical studies. *Eur J Pediatr* **136**: 319-323.
- [158] Duran M, Bruinvis L, Wadman SK (1986) Quantitative gas chromatographic determination of urinary hydantoin-5-propionic acid in patients with disorders of folate/vitamin B₁₂ metabolism. *J Chromatogr* **381**: 401-405.
- [159] Rosenblatt DS, Erbe RW (1977) Methylenetetrahydrofolate reductase in cultured human cells. I. Growth and metabolic studies. *Pediatr Res* **11**: 1137-1141.
- [160] Ogier de Baulny H, Gerard M, Saudubray JM, Zittoun J (1998) Remethylation defects: guidelines for clinical diagnosis and treatment. *Eur J Pediatr* **157**(2): S77-S83.
- [161] Hyland K, Smith I, Bottiglieri T, Perry J, Wendel U, Clayton PT, Leonard JV (1988) Demyelination and decreased S-adenosylmethionine in 5,10-methylenetetrahydrofolate reductase deficiency. *Neurology* **38**: 459-462.
- [162] Kishi T, Kawamura I, Harada Y, Eguchi T, Sakura N, Ueda K, Narisawa K, Rosenblatt DS (1994) Effect of betaine on S-adenosylmethionine levels in the cerebrospinal fluid in a patient with methylenetetrahydrofolate reductase deficiency and peripheral neuropathy. *J Inher Metab Dis* **17**: 560-565.
- [163] Lochrer FMT, Angst CP, Haefeli WE, Jordan PP, Ritz R, Fowler B (1996) Low whole-blood S-adenosylmethionine and correlation between 5-methyltetrahydrofolate and homocysteine in coronary artery disease. *Arterioscler Thromb Vasc Biol* **16**(6): 727-733.
- [164] Goyette P, Rosenblatt D, Rozen R (1998) Homocystinuria (methylenetetrahydrofolate reductase deficiency) and mutation of factor V gene. *J Inher Metab Dis* **21**: 690-691.
- [165] Kang SS, Wong PWK, Bock HGO, Horwitz A, Grix A (1991) Intermediate hyperhomocysteinemia resulting from compound heterozygosity of methylenetetrahydrofolate reductase mutations. *Am J Hum Genet* **48**: 546-551.

Chapter 2

- [166] Goyette P, Christensen B, Rosenblatt DS, Rozen R (1996) Severe and mild mutations in cis for the methylenetetrahydrofolate reductase (MTHFR) gene, and description of five novel mutations in MHTFR. *Am J Hum Genet* **59**: 1268-1275.
- [167] Wendel U, Bremer HJ (1983) Betaine in the treatment of homocystinuria due to 5,10-methylene THF reductase deficiency. *Eur J Pediatr* **142**: 147-150.
- [168] Sakura N, Ono H, Nomura H, Ueda H, Fujita N (1998) Betaine dose and treatment intervals in therapy for homocystinuria due to 5,10-methylenetetrahydrofolate reductase deficiency. *J Inher Metab Dis* **21**: 84-85.
- [169] Fowler B, Schutgens RBH, Rosenblatt DS, Smit GPA, Lindemans J (1997) Folate-responsive homocystinuria and megaloblastic anaemia in a female patient with functional methionine synthase deficiency (cblE disease). *J Inher Metab Dis* **20**: 731-741.
- [170] Cooper BA, Rosenblatt DS (1987) Inherited defects of vitamin B₁₂ metabolism. *Ann Rev Nutr* **7**: 291-320.
- [171] Yang YM, Ducos R, Rosenberg AJ, Catrou PG, Levine JS, Podell ER, Allen RH (1985) Cobalamin malabsorption in three siblings due to an abnormal intrinsic factor that is markedly susceptible to acid and proteolysis. *J Clin Invest* **76**: 2057-2065.
- [172] Hewitt JE, Gordon MM, Taggart RT, Mohandas TK, Alpers DH (1991) Human gastric intrinsic factor: characterization of cDNA and genomic clones and localization to human chromosome 11. *Genomics* **10**: 432-440.
- [173] Gräsbeck R (1972) Familial selective vitamin B₁₂ malabsorption. *N Engl J Med* **287**: 358.
- [174] Carmel R (1988) Plasma R binder deficiency. *N Engl J Med* **318**: 1401-402.
- [175] Haurani FI, Hall CA, Rubin R (1979) Megaloblastic anemia as a result of an abnormal transcobalamin II. *J Clin Invest* **64**: 1253-1259.
- [176] Seligman PA, Steiner LL, Allen RH (1980) Studies of a patient with megaloblastic anemia and an abnormal transcobalamin II. *N Engl J Med* **303**: 1209-1212.

- [177] Watkins D, Rosenblatt DS (1989) Functional methionine synthase deficiency (cbIE and cbIG): clinical and biochemical heterogeneity. *Am J Med Genet* **34**: 427-434.
- [178] Steen C, Rosenblatt DS, Scheying H, Braeuer HC, Kohlschütter A (1997) Cobalamin E (cbIE) disease: A severe neurological disorder with megaloblastic anemia, homocystinuria and low serum methionine. *J Inher Metab Dis* **20**: 705-706.
- [179] Rosenblatt DS, Cooper BA, Pottier A, Lue-Shing H, Matiaszuk N, Grauer K (1984) Altered vitamin B12 metabolism in fibroblasts from a patient with megaloblastic anemia and homocystinuria due to a new defect in methionine biosynthesis. *J Clin Invest* **74**: 2149-2156.
- [180] Wilson A, Leclerc D, Rosenblatt DS, Gravel RA (1999) Molecular basis for methionine synthase reductase deficiency in patients belonging to the cbIE complementation group of disorders in folate/cobalamin metabolism. *Hum Mol Genet* **8**: 2009-2016.
- [181] Wilson A, Leclerc D, Saberi F, Campeau E, Hwang HY, Shane B, Phillips JA 3rd, Rosenblatt DS, Gravel RA (1998) Functionally null mutations in patients with the cbIG variant form of methionine synthase deficiency. *Am J Med Genet* **63**: 409-414.
- [182] Rosenblatt DS, Hosack A, Matiaszuk NV, Cooper BA, Laframboise R (1985) Defect in vitamin B₁₂ release from lysosomes: newly described inborn error of vitamin B₁₂ metabolism. *Science* **228**: 1319-1321.
- [183] Pezacka EH (1993) Identification and characterization of two enzymes involved in the intracellular metabolism of cobalamin. Cyanocobalamin beta-ligand transferase and microsomal cob(III)alamin reductase. *Biochim Biophys Acta* **1157**(2): 167-177.
- [184] Rosenblatt DS, Aspler AL, Shevell MI, Pletcher BA, Fenton WA, Seashore MR (1997) Clinical heterogeneity and prognosis in combined methylmalonic aciduria and homocystinuria. *J Inher Metab Dis* **20**: 528-538.
- [185] Ellaway C, Christodoulou J, Kamath R, Carpenter K, Wilcken B (1998) The association of protein-losing enteropathy with cobalamin C defect. *J Inher Metab Dis* **21**:17-22.

Chapter 2

- [186] Baumgartner ER, Fowler B, Wendel U (1996) Hereditary defect of cobalamin metabolism (homocystinuria and methylmalonic aciduria) of juvenile onset. *J Neurol Neurosurg Psychiatry* **60**(1): 107-108.
- [187] Wyss M, Kaddurah-Daouk R (2000) Creatine and creatinine metabolism. *Physiol Rev* **80**(3): 1107-1213.
- [188] Persky AM, Brazeau GA (2001) Clinical pharmacology of the dietary supplement creatine monohydrate. *Pharmacol Rev* **53**: 161-176.
- [189] Wyss M, Schulze A (2002) Health implications of creatine: can oral creatine supplementation protect against neurological and atherosclerotic disease? *Neuroscience* **112**(2): 243-260.
- [190] Von Figura K, Hanefeld F, Isbrandt D, Stöckler-Ipsiroglu S (2001) Guanidinoacetate methyltransferase deficiency. In: Scriver, Beaudet, Valle, Sly (Eds). *The Metabolic and Molecular Basis of Inherited Disease*. New York: McGraw Hill, p 1897-1908.
- [191] Stöckler-Ipsiroglu S, Stromberger C, Item CB, Mühl A (2002) Disorders of creatine metabolism. In: Blau, Duran, Blaskovics, Gibson, editors. *Physician's guide to the laboratory diagnosis of metabolic diseases*. Berlin: Springer-Verlag, p 467-480.
- [192] Item CB, Stöckler-Ipsiroglu S, Stromberger C, Mühl A, Alessandri MG, Bianchi MC, Tosetti M, Fornai F, Cioni G (2001) Arginine:glycine amidinotransferase deficiency: the third inborn error of creatine metabolism in humans. *Am J Hum Genet* **69**:1127-1133.
- [193] Stöckler S, Isbrandt D, Hanefeld F, Schmidt B, von Figura K (1996) Guanidinoacetate methyltransferase deficiency: the first inborn error of creatine metabolism in man. *Am J Hum Genet* **58**(5): 914-22.
- [194] Salomons GS, van Dooren SJM, Verhoeven NM, Cecil KM, Ball WS, Degrauw TJ, Jakobs C (2001) X-linked creatine transporter gene (*SLC6A8*) defect: A new creatine-deficiency syndrome. *Am J Hum Genet* **68**: 1497-1500.
- [195] Stöckler S, Holzbach U, Hanefeld F, Marquardt I, Helms G, Requart M, Hänicke W, Frahm J (1994) Creatine Deficiency in the Brain: A New, Treatable Inborn Error of Metabolism. *Pediatr Res* **36**(3): 409-413.

- [196] Stöckler-Ipsiroglu S, Jakobs C (2002) Creatine Deficiency Syndromes. Publication of Workshop Results of the 34th European Metabolic Group Meeting, Zurich, p 24-32.
- [197] Schulze A, Hess T, Wevers R, Mayatepeck E, Bachert P, Maresceau B (1997) Creatine deficiency syndrome caused by guanidinoacetate methyltransferase deficiency: diagnostic tools for a new inborn error of metabolism. *J Pediatr* **131**: 626-631.
- [198] Ganesan V, Johnson A, Connelly A, Eckhardt S, Surtees RAH (1997) Guanidinoacetate Methyltransferase Deficiency: New Clinical Features. *Pediatr Neurol* **17**: 155-157.
- [199] Caldeira Araújo H, Smit W, Verhoeven N, Salomons G, Silva S, Vasconcelos R, Tomás H, Tavares de Almeida I, Jakobs C, Duran M (2003) Guanidinoacetate methyltransferase deficiency identified in mentally retarded adults. Submitted to *Am J Med Genet*.
- [200] Ilas J, Muhl A, Stockler-Ipsiroglu S (2000) Guanidinoacetate methyltransferase (GAMT) deficiency: non-invasive enzymatic diagnosis of a newly recognized inborn error of metabolism. *Clin Chim Acta* **290**(2): 179-188.
- [201] Item CB, Stromberger C, Mühl A, Edlinger C, Bodamer OA, Schulze A, Surtees R, Leuzzi V, Salomons GS, Jakobs C, Stöckler-Ipsiroglu S (2002) Denaturing Gradient Gel Electrophoresis for the Molecular Characterization of Six Patients with Guanidinoacetate Methyltransferase Deficiency. *Clin Chem* **48**(5): 767-769.
- [202] Stöckler S, Hanefeld F, Frahm J (1996) Creatine replacement therapy in guanidinoacetate methyltransferase deficiency, a novel inborn error of metabolism. *Lancet* **348**: 789-790.
- [203] Stöckler S, Marescau B, De Deyn PP, Trijbels JM, Hanefeld F (1997) Guanidino compounds in guanidinoacetate methyltransferase deficiency, a new inborn error of creatine synthesis. *Metabolism* **46**(10): 1189-1193.
- [204] Leuzzi V, Bianchi MC, Tosetti M, Carducci C, Cerquiglini A, Cioni G, Antonozzi I (2000) Brain creatine depletion: Guanidinoacetate methyltransferase deficiency (improving with creatine supplementation). *Neurology* **55**: 1407-1409.

Chapter 2

- [205] Schulze A, Mayatepek E, Bachert P, Maresceau B, De Deyn PP, Rating D (1998) Therapeutic trial of arginine restriction in creatine deficiency syndrome. *Eur J Pediatr* **157**: 606-607.
- [206] Schulze A, Ebinger F, Rating D, Mayatepek E (2001) Improving treatment of guanidinoacetate methyltransferase deficiency: reduction of guanidinoacetic acid in body fluids by arginine restriction and ornithine supplementation. *Mol Genet Metab* **74**(4): 413-419.
- [207] Schulze A, Bachert P, Schlemmer H, Harting I, Polster T, Salomons G, Verhoeven N, Jakobs C, Fowler B, Hoffmann G, Mayatepek E (2003) Lack of creatine in muscle and brain in an adult with GAMT deficiency. *Ann Neurol* **53**: 248-251.
- [208] Battini R, Leuzzi V, Carducci C, Tosetti M, Bianchi MC, Item CB, Stöckler-Ipsiroglu S, Cioni G (2002) Creatine depletion in a new case with AGAT deficiency: clinical and genetic study in a large pedigree. *Mol Genet Metab* **77**(4): 326-331.
- [209] Schulze A (2003) Creatine deficiency syndromes. *Mol Cell Biochem* **244**: 143-150.
- [210] Cecil KM, Salomons GS, Ball WS, Wong B, Chuck G, Verhoeven NM, Jakobs C, DeGrauw TJ (2001) Irreversible brain creatine deficiency with elevated serum and urine creatine: A creatine transporter defect? *Ann Neurol* **49**: 401-404.
- [211] Tada K. Nonketotic hyperglycinemia (2000) In Fernandes J, Saudubray J-M, Van den Berghe G (Eds): *Inborn Metabolic Diseases-Diagnosis and Treatment*. Berlin: Springer-Verlag, p 254-258.
- [212] Hamosh A, Johnston MV (2001) Nonketotic Hyperglycinemia. In Scriver, Beaudet, Valle, Sly (Eds): *The Metabolic and Molecular Basis of Inherited Disease*. New York: McGraw Hill, p 2065-2078.
- [213] Zarbin MA, Wamsley JK, Kuhar MJ (1981) Glycine receptor: light microscopic localization with [³H]strychnine. *J Neurosci* **1**: 532-547.
- [214] Kikuchi G (1983) The glycine cleavage system: composition, reaction mechanism and physiological significance. *Mol Cell Biochem* **1**: 169-187.

- [215] Hayasaka K, Tada K, Kikuchi G, Winter S, Nyhan WL (1983) Nonketotic hyperglycinemia: two patients with primary defects of P-protein and T-protein, respectively, in the glycine cleavage system. *Pediatr Res* **17**: 967-970.
- [216] Quackenbush EJ, Kraemer KH, Gahl WA, Schirch V, Whiteman DA, Levine K, Levy HL (1999) Hypoglycinaemia and psychomotor delay in a child with xeroderma pigmentosum. *J Inher Metab Dis* **22**: 915-924.
- [217] Van Hove JLK, Lazeyras F, Zeisel SH, Bottiglieri T, Hyland K, Charles HC, Gray L, Jaeken J, Kahler SG (1998) One-methyl group metabolism in non-ketotic hyperglycinaemia: Mildly elevated cerebrospinal fluid homocysteine levels. *J Inher Metab Dis* **21**: 799-811.
- [218] MacDonald JT, Sher PK (1977) Ophthalmoplegia as a sign of metabolic disease in the newborn. *Neurology* **27**: 971-973.
- [219] Tada K, Kure S (1983) Nonketotic hyperglycinemia: molecular lesion, diagnosis and pathophysiology. *J Inher Metab Dis* **16**: 691-703.
- [220] Hayasaka K, Tada K, Fueki N, Aikawa D (1990) Prenatal diagnosis of nonketotic hyperglycinemia: enzymatic analysis of the glycine cleavage system in chorionic villi. *J Pediatr* **16**: 444-445.
- [221] Hayasaka K, Nanao K, Takada G, Ikeda KO, Motowaka Y (1993) Isolation and sequence determination of cDNA encoding human T-protein of the glycine cleavage system. *Biochem Biophys Res Commun* **192**: 766-771.
- [222] Koyata H, Hiraga K (1991) The glycine cleavage system: structure of a cDNA encoding human H-protein, and partial characterization of its gene in patients with hyperglycinemias. *Am J Hum Genet* **48**: 351-361.
- [223] Koyata H, Hiraga K (1991) Partial structure of the human H-protein gene. *Biochem Biophys Res Commun* **178**: 1072-1077.
- [224] Trijbels JM, Monnens LA, van der Zee SP, Vrenken JA, Sengers RC, Schretlen ED (1974) A patient with nonketotic hyperglycinemia: biochemical findings and therapeutic approaches. *Pediatr Res* **8**: 598-605.
- [225] Spielberg SP, Lucky AW, Schulman JD, Kramer LI, Hefner L, Goodman SI (1976) Failure of leucovorin therapy in nonketotic hyperglycinemia. *J Pediatr* **89**: 681-682.

Chapter 2

- [226] Jaeken J, Corbeel L, Casaer P, Carchon H, Eggermont E, Eeckels R (1977) Dipropylacetate (valproate) and glycine metabolism. *Lancet* **2**: 617.
- [227] Ohya Y, Ochi N, Mizutani N, Hayakawa C, Watanabe K (1991) Nonketotic hyperglycinemia: Treatment with NMDA antagonist and consideration of neuropathogenesis. *Pediatr Neurol* **7**: 65-68.
- [228] Ferkany JW, Borosky SA, Clissold DB, Pontecorvo MJ (1988) Dextromethorphan inhibits NMDA-induced convulsions. *Eur J Pharmacol* **151**: 151-154.
- [229] Hamosh A, Maher JF, Bellus GA, Rasmussen SA, Johnston MV (1998) Long-term use of high-dose benzoate and dextromethorphan for the treatment of nonketotic hyperglycinemia. *J Pediatr* **132**: 709-713.
- [230] Rho J, Donevan SD, Rogawski MA (1994) Mechanism of action of the anticonvulsant felbamate: opposing effects on N- methyl-D-aspartate and gamma-aminobutyric acidA receptors. *Ann Neurol* **35**: 229-234.
- [231] De Koning, Snell K, Duran M, Berger R, Poll-The BT, Surtees R (2003) L-serine in disease and development. *Biochem J* **371**: 653-661.
- [232] Klomp LW, de Koning TJ, Malingre HE, van Beurden EA, Brink M, Opdam FL, Duran M, Jaeken J, Pineda M, van Maldergem L, Poll-The BT, van den Berg IE, Berger R (2000) Molecular characterization of 3-phosphoglycerate dehydrogenase deficiency – a neurometabolic disorder associated with reduced L-serine biosynthesis. *Am J Hum Genet* **67**: 1389-1399.
- [233] Jaeken J, Detheux M, Van Maldergem L, Frijns JP, Alliet P, Foulon M, Carchon H, Van Schaftingen E (1996) 3-Phosphoglycerate dehydrogenase deficiency and 3-phosphoserine phosphatase deficiency: inborn errors of serine biosynthesis. *J Inher Metab Dis* **19**: 223-226.
- [234] Catsman-Berrevoets CE, de Klerk JBC, Huymans JGM, Duran M (1997) Inborn error of serine biosynthesis, a new phenotype. *Eur J Paediat Neurol* **1**: A43.
- [235] Jaeken J, Detheux M, Van Maldergem L, Foulon M, Carchon H, Van Schaftingen E (1996) 3-Phosphoglycerate dehydrogenase deficiency: an inborn error of serine biosynthesis. *Arch Dis Child* **74**: 542-545.

- [236] Jaeken J (2000) Disorders of proline and serine metabolism. In Fernandes J, Saudubray J-M, van den Berghe G (Eds): *Inborn Metabolic Diseases-Diagnosis and Treatment*. Berlin: Springer-Verlag, p 260-264.
- [237] De Koning TJ, Jaeken J, Pineda M, van Maldergem L, Poll-The BT, van der Knaap MS (2000) Hypomyelination and reversible white matter attenuation in 3-phosphoglycerate dehydrogenase deficiency. *Neuropediatrics* **31**: 287-292.
- [238] De Koning TJ, Duran M, Dorland L, Gooskens R, Van Schaftingen E, Jaeken J, Blau N, Berger R, Poll-The BT (1998) Beneficial effects of L-serine and glycine in the management of seizures in 3-phosphoglycerate dehydrogenase deficiency. *Ann Neurol* **44**: 261-265.
- [239] De Koning TJ, Duran M, Dorland L, Jakobs C, Wevers RA, Berger R, Poll-The BT (2000) Neurotransmitters in 3-phosphoglycerate dehydrogenase deficiency. *Eur J Pediatr* **159**: 939-940.
- [240] De Koning TJ, Duran M, van Maldergem L, Pineda M, Dorland L, Gooskens R, Jaekens J, Poll-The BT (2002) Congenital microcephaly and seizures due to 3-phosphoglycerate dehydrogenase deficiency: outcome of treatment with amino acids. *J Inher Metab Dis* **25**: 119-125.
- [241] Jaeken J, Dethoux M, Fryns JP, Collet JF, Alliet P, van Schaftingen (1997) Phosphoserine phosphatase deficiency in a patient with Williams syndrome. *J Med Genet* **34**: 594-596.
- [242] Scott, CR (2001) Sarcosinemia. In: Scriver, Beaudet, Valle, Sly (Eds). *The Metabolic and Molecular Basis of Inherited Disease*. New York: McGraw Hill, p 2057-2063.
- [243] Meissner T, Mayatepek E (1997) Sarcosinemia in a patient with severe progressive neurological damage and hypertrophic cardiomyopathy. *J Inher Metab Dis* **20**: 717-718.
- [244] Moolenaar SH, Poggi-Bach J, Engelke UFH, Corstiaensen JMB, Heerschap A, de Jong JGN, Binzak BA, Vockley J, Wevers RA (1999) Defect in dimethylglycine dehydrogenase, a new inborn error of metabolism: NMR spectroscopy study. *Clin Chem* **45**(4): 459-464.
- [245] Allen RH, Stabler SP, Lindenbaum J (1993) Serum betaine, N,N-dimethylglycine and N-methylglycine levels in patients with cobalamin and

Chapter 2

- folate deficiency and related inborn errors of metabolism. *Metabolism* **42**(11): 1448-1460.
- [246] Gerritsen T, Waisman HA (1966) Hypersarcosinemia: an inborn error of metabolism. *N Engl J Med* **275**: 66-69.
- [247] Lemieux B, Auray-Blais C, Giguere R, Shapcott D, Scriver CR (1988) Newborn urine screening experience with over one million infants in the Quebec Network of Genetic Medicine. *J Inher Metab Dis* **11**: 45-55.
- [248] Reuber BE, Karl C, Reimann SA, Mihalik SJ, Dodt G (1997) Cloning and functional expression of a mammalian gene for a peroxisomal sarcosine oxidase. *J Biol Chem* **272**(10): 6766-6776.
- [249] Dudman NP, Wilcken DE, Wang J, Lynch JF, Macey D, Lundberg P (1993) Disordered methionine/homocysteine metabolism in premature vascular disease. Its occurrence, cofactor therapy, and enzymology. *Arterioscler Thromb* **13**: 1253-1260.
- [250] Lundberg P, Dudman NP, Kuchel PW, Wilcken DE (1995) H NMR determination of urinary betaine in patients with premature vascular disease and mild homocysteinemia. *Clin Chem* **41**: 275-283.
- [251] Duran M (2002) Miscellaneous analyses. In: Blau, Duran, Blaskovics, Gibson, editors. *Physician's guide to the laboratory diagnosis of metabolic diseases*. Berlin: Springer-Verlag, p 45-55.
- [252] Duran M, Dorland L, de Bree PK, Berger R (1994) Selective screening for amino acid disorders. *Eur J Pediatr* **153**[Suppl 1]: S33-S37.
- [253] Klee GG (2000) Cobalamin and folate evaluation: measurement of methylmalonic acid and homocysteine vs vitamin B₁₂ and folate. *Clin Chem* **46**(8B): 1277-1283.
- [254] Wright AJA, Finglas PM, Southon S (1998) Erythrocyte folate analysis: a cause of concern? *Clin Chem* **44**(9): 1886-1891.
- [255] Shih V (2002) Amino acid analysis. In: Blau, Duran, Blaskovics, Gibson, editors. *Physician's guide to the laboratory diagnosis of metabolic diseases*. Berlin: Springer-Verlag, p 11-26.

- [256] Hoffmann GF, Feyh P (2002) Organic acid analysis. In: Blau, Duran, Blaskovics, Gibson, editors. Physician's guide to the laboratory diagnosis of metabolic diseases. Berlin: Springer-Verlag, p 27-44.
- [257] Kuhara T (2001) Diagnosis of inborn errors of metabolism using filter paper urine, urease treatment, isotope-dilution and gas chromatography-mass spectrometry. *J Chromat B* **758**: 3-25.
- [258] Millington DS (2002) Tandem mass spectrometry in clinical diagnosis. In: Blau, Duran, Blaskovics, Gibson, editors. Physician's guide to the laboratory diagnosis of metabolic diseases. Berlin: Springer-Verlag, p 57-75.
- [259] Chace DH, Adam BW, Smith SJ, Alexander JR, Hillman SL, Hannon WH (1999) Validation of accuracy-based amino acid reference materials in dried-blood spots by tandem mass spectrometry for newborn screening assays. *Clin Chem* **45**(8): 1269-1277.
- [260] Sweetman L (2001) Newborn screening by tandem mass spectrometry: gaining experience. *Clin Chem* **47**(11): 1937-1938.
- [261] Wevers R, Engelke U, Moolenaar S (2002) Proton NMR spectroscopy of body fluids. In: Blau, Duran, Blaskovics, Gibson, editors. Physician's guide to the laboratory diagnosis of metabolic diseases. Berlin: Springer-Verlag, p 77-85.
- [262] Nexø E, Engbaek F, Ueland P, Westby C, O'Gorman P, Johnston C, Kase BF, Guttormsen AB, Alfheim I, McPartlin J, Smith D, Møller J, Rasmussen K, Clarke R, Scott J, Refsum H (2000) Evaluation of novel assays in clinical chemistry: Quantification of plasma total homocysteine. *Clin Chem* **46**(8): 1150-1156



PART II

**PURINE AND PYRIMIDINE ANALYSIS AND
REFERENCE VALUES**



**A NEW SOLID-PHASE EXTRACTION PROCEDURE FOR PURINE
AND PYRIMIDINE ANALYSIS.**

**Helena Caldeira Araújo, Helena Silva, Helena Tomás, Marinus Duran
and Isabel Tavares de Almeida .**

Submitted for publication in *Journal of Chromatography B*.

ABSTRACT

A new solid phase extraction method for urinary purine and pyrimidine metabolites is described. The method has shown good recoveries and reproducibilities for the fifteen tested compounds. The validity of the method was demonstrated for mixtures of standard compounds, urine samples spiked with the pure studied compounds as well as for urine samples of patients with various established defects. The method has shown to be suitable for screening purposes and for the follow-up of patients under treatment.

INTRODUCTION

Inherited disorders of purine and pyrimidine metabolism cover a broad spectrum of illnesses and are associated with serious, sometimes fatal, clinical consequences. These defects may cause neurological, immunological, haematological, and renal problems and in some cases, several forms of clinical presentation complicating the diagnosis [1].

The diagnosis of the majority of these disorders can be achieved through analysis of urinary purine and pyrimidine metabolites. Recently, methods using liquid chromatography coupled to tandem mass spectrometry (LC-MS / MS) which provide precise identification, even for minute amounts of compounds, have been reported. Although these methods overcome the qualitative analysis problems, the specific required equipment is still not available in most clinical laboratories which transforms the high-performance liquid chromatography (HPLC) coupled to multiwavelength UV detection into the most widely used system [2-6].

The complexity of the urine matrix, the relative difference among nucleobase and nucleoside levels and those of uric acid and creatinine make it difficult to identify the metabolites of interest. Moreover, at low metabolite levels, the spectrum similarity to the pure compounds strongly decreases and the quantitative analysis accuracy is also compromised.

Sample treatment prior to HPLC analysis has been used to overcome those problems. A variety of methods based on classic anion-exchange resins or on solid-phase extraction (SPE) procedures using reversed-phase cartridges,

Chapter 3

have been reported [7-9]. However, some of them deal with a limited number of compounds or are quite time-consuming.

In the present report, we describe a new SPE method that uses an anion-exchange matrix for the isolation of urinary purine and pyrimidine intermediates. The method was validated by HPLC analysis of the collected fractions, using mixtures of authentic compounds or urines spiked with different metabolites as well as urines from patients with specific established defects.

EXPERIMENTAL

Chemicals

Reference compounds were obtained from Sigma (St. Louis, MO, U.S.A.). Stock standard solutions (2500 μ M) of the individual compounds tested were prepared in purified water and a few drops of 2N sodium hydroxide (NaOH) were added when necessary to achieve a clear solution.

Methanol was HPLC grade and the other reagents were of analytical grade, all from Merck (Darmstadt, Germany). Water was purified in a Milli-Q system from Millipore (Bedford, MA, U.S.A.).

SPE was performed using Oasis Max (mixed-mode sorbent) extraction cartridges (6cc, 150 mg) obtained from Waters Corporation (Milford, MA, USA).

Equipment

HPLC analysis was carried out in a Millipore-Waters (Waters Division, Milford, MA, USA) system consisting of a model 600E Multisolvent Delivery System, a U6K injector, a model 486 UV detector set at wavelength 254 nm in-line with a model 996 photodiode array detector for multiwavelength detection.

The signal output was acquired on a computer using dedicated software (Millenium³², Waters Corporation, Milford, MA, U.S.A.).

Sample preparation

First morning urines were collected in sterilized flasks from apparently healthy subjects after 2 days on a low purine, caffeine-free diet. They were stored within 2 hours at -30°C until analysis. Before SPE they were sonicated for 1 hour at 37°C and 60 µl of internal standard (3-methyl-guanine, 5000 µM) was added to 1940 µl of urine, to obtain a final concentration of 150 µM and then it was vortex-mixed.

SPE Method

Oasis MAX cartridges were equilibrated, just prior to use, with 1 ml of water, then 1 ml of a 1:1 (v/v) mixture of water and methanol and at the end 1 ml of water. Standard solutions and urine samples spiked with known amounts of metabolites and internal standard (3-methyl-guanine), adjusted to pH \geq 9.0 with 2N sodium hydroxide, were loaded (500 µl) on the top of the cartridges, which were then washed with 1 ml of a 95:5 (v/v) mixture of 50 mM sodium acetate and methanol. All the tested metabolites except for orotidine and orotic acid were eluted with 1 ml of a 40:60 (v/v) mixture of 2M formic acid and methanol. Orotidine and orotic acid were then eluted with 1 ml of a 75:25 (v/v) mixture of 6M formic acid and methanol. The eluates were collected separately and were dried under nitrogen atmosphere at 37°C. The dried residues were then redissolved in a variable volume of 0.01M potassium dihydrogenophosphate (HPLC starting buffer), which depended on the initial concentration of the studied metabolites and were stored at -30°C if not immediately submitted to HPLC analysis.

Column liquid chromatography

The separation was carried out at 25°C using a Supelcosil LC-18-S (250 x 4.6 mm i.d., 5µm particle size) analytical column (Supelco, Bellefonte, PA, U.S.A.) protected by a LiChrospher 60 RP-select B 5 µm guard-column from Merck (Darmstadt, Germany).

Chapter 3

The mobile phases consisted of 0.01M potassium dihydrogenophosphate buffer, pH 5.01 (eluent A) and a 1:1 (v/v) mixture of 0.02M potassium dihydrogenophosphate and methanol, pH 5.87 (eluent B). The eluents were filtered through 0.45 μm GHP membrane filters (Pall Corporation, Ann Arbor, MI, U.S.A.) and degassed by sonication just prior to use.

The studied compounds were eluted by a step gradient, as previously reported [10], starting with 100% of eluent A over 8 min; 0% to 60 % of eluent B over 20 min by step gradient and then 60% to 0% of eluent B over 2 min linearly. The flow rate was 0.7 ml over 7 min; from 0.7 to 1.4 ml in 1 min; 1.4 ml over 20 min and back to 0.7 ml in 2 min. An equilibration period of 10 min with eluent A was allowed between runs.

RESULTS

The chromatograms obtained from the analysis of purines and pyrimidines at a final concentration of 250 μM each compound, in a standard solution and in spiked urine, before and after SPE, are shown in Fig.1 and 2, respectively. The SPE procedure has not interfered with the chromatographic characteristics of the standard compounds. The relative retention times, the absorbance ratios (280 / 254 nm) and the respective UV spectra were identical to the ones obtained for each authentic standard not submitted to the SPE procedure. Moreover, no double peaks were detected. The clean up of some interfering compounds as well as of creatinine and part of the uric acid, in the earlier part of the urine chromatographic profile, allowed the correct identification of the earliest eluted compounds of interest. In the latter part of the chromatogram, the interference of hippuric acid and other unknown compounds was not fully overcome, but the purity of the UV spectrum of the tested urine metabolites was clearly higher, improving the identification precision.

The extraction efficiency of the SPE procedure was evaluated for the various studied compounds in mixtures of standard solutions in the range of 5 – 250 μM using six different concentrations (5, 10, 20, 50, 150 and 250 μM). The recovery results summarised in Table I represent the mean of

three independent assays for each concentration. For the low concentration range (5 –20 μM), recoveries varied between 79 – 109 % with a CV of 2–11%, for the majority of the compounds. Exceptions were 5-hidroxy-methyluracil, pseudouridine, deoxyinosine and deoxyguanosine with a recovery range of 60 – 81 % and a CV of 2 – 18 %. For the high concentration range (50 – 250 μM), the recoveries varied between 81 – 108 % (CV: 0.3 – 10.0%), except for 5-hidroxy-methyluracil (75 %) and pseudouridine (74 %) at the concentration of 50 μM . As it was expected a slight improvement was observed for the high concentration range compared to the lower one.

The recovery (data not shown) of orotidine and orotic acid, eluted from the cartridge in a further elution step as described in 2.4 had poor reproducibility. The described SPE procedure was not considered suitable for the study of those compounds.

The linear correlation, after SPE, between relative peak areas (area / IS area) and the respective concentration were calculated for the low (5 –20 μM) and high (50 – 250 μM) concentration ranges. The correlation coefficients (r^2) found varied between 0.990 and 0.999 for the low range, except for pseudouridine (0.969) and deoxyguanosine (0.986), and from 0.987 to 0.998 for the high range, except for adenine (0.982).

Recoveries of urine sample compounds were evaluated by comparing the concentration of each compound in spiked and unspiked urine aliquots prepared from the same urine pool and submitted to the SPE procedure. Aliquots enriched with the different authentic standards, at a final concentration of 50, 150 and 250 μM for each compound, were analysed. The concentration of each compound was calculated using the respective equation of linear regression found for the authentic standards after being submitted to the SPE procedure. The recovery data shown in Table II, represent the mean of three independent assays for each tested concentration. Recoveries were $\geq 84\%$ with a CV $\leq 8.8\%$ for all compounds except for uracil (64.6–73.0%). One possible cause could be an overestimation of that metabolite on the urine not supplemented, due to a co-eluting contaminant which had not been fully cleaned-up.

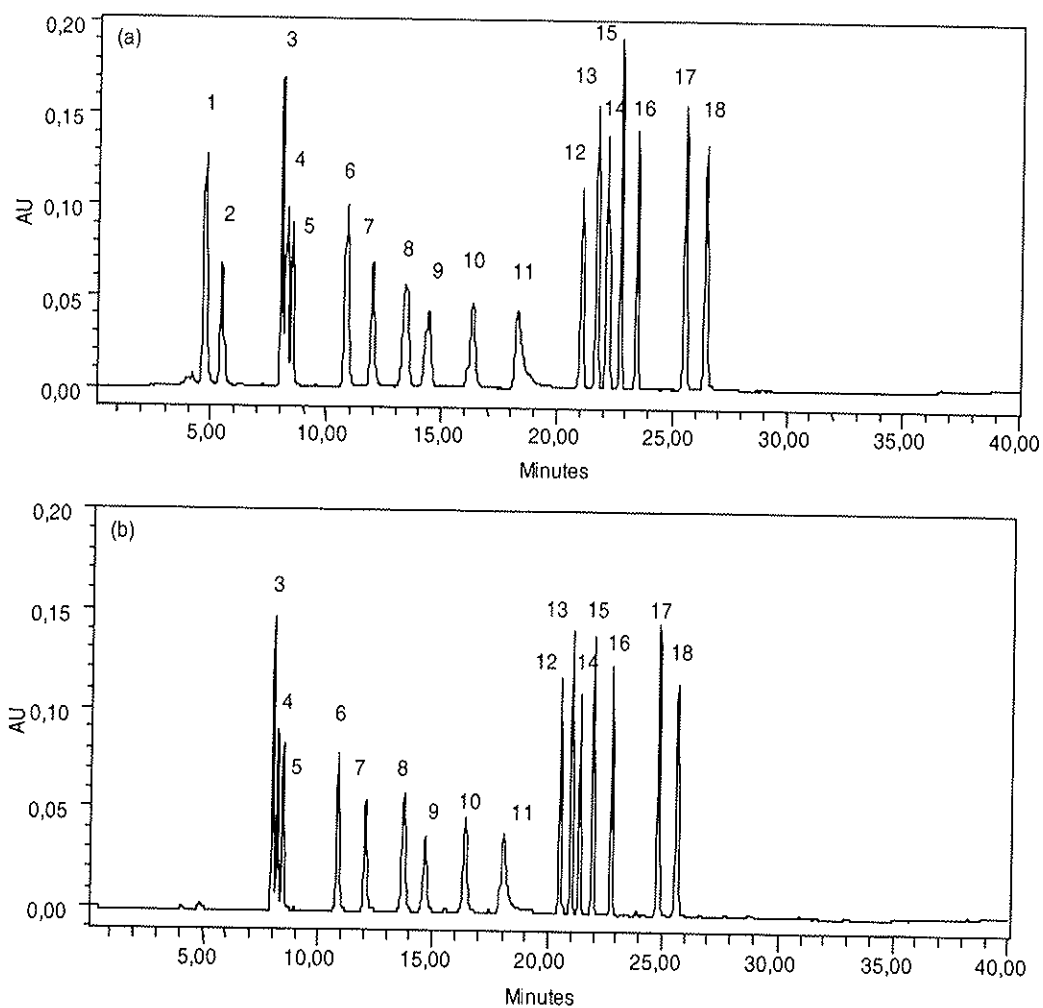

Fig. 1 - Chromatograms of a mixture of authentic standard compounds before (a) and after (b) SPE.

Peaks: (1) orotidine; (2) orotic acid; (3) uracil; (4) 5-hydroxy-methyluracil; (5) pseudouridine; (6) hypoxanthine; (7) xanthine; (8) uridine; (9) thymine; (10) 3-methylguanine (IS); (11) adenine; (12) inosine; (13) guanosine; (14) deoxyinosine; (15) deoxyguanosine; (16) thymidine; (17) adenosine; (18) deoxyadenosine.

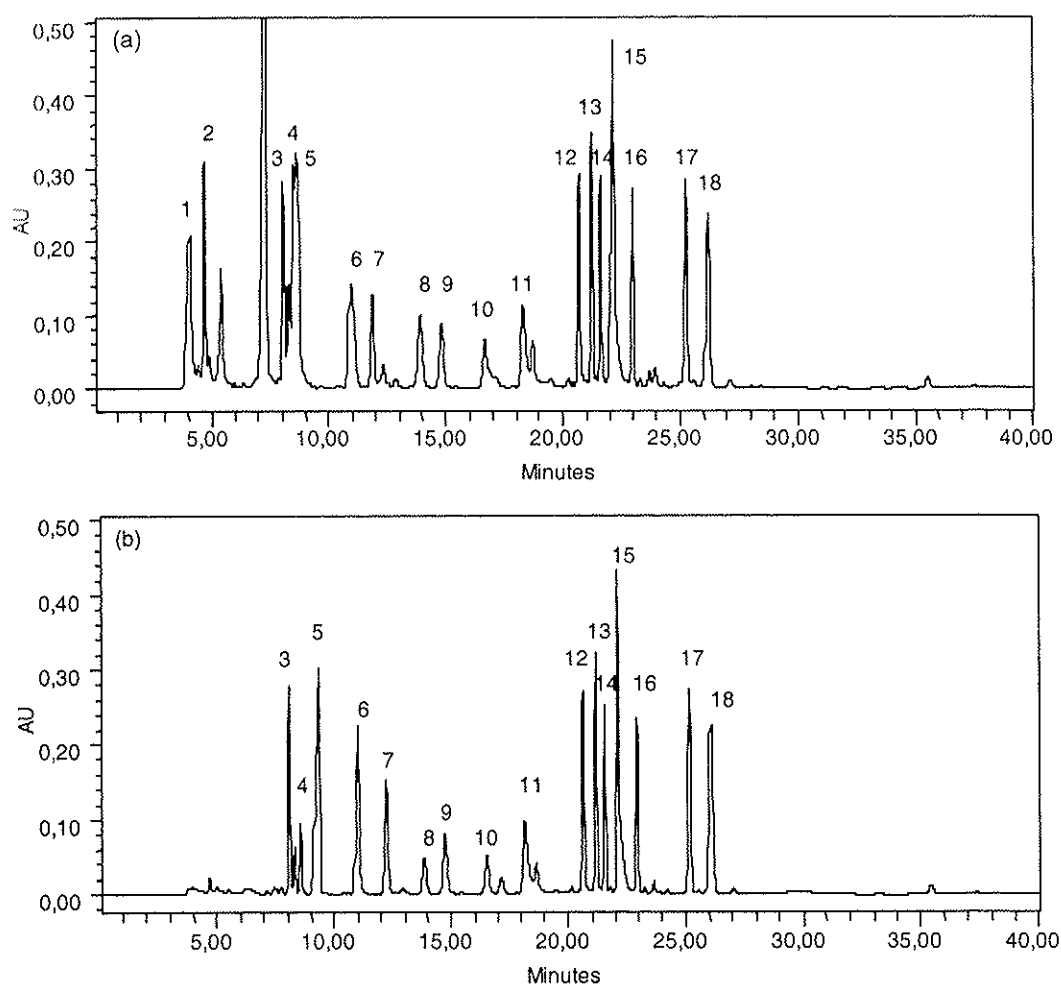

Fig. 2 - Chromatograms of a spiked urine with authentic compounds before (a) and after (b) SPE. Peak identity is the same as in Fig. 1.

Chapter 3

Table I. Mean recoveries and CV of standard compounds at (A) a low concentration range and (B) a high concentration range.

(A)

Compound	5 μ M		10 μ M		20 μ M	
	Rec. (%) [*]	CV (%)	Rec. (%) [*]	CV (%)	Rec. (%) [*]	CV (%)
Uracil	80.4	11.2	91.2	7.2	87.0	9.3
5-OH-methyluracil	73.0	10.1	70.8	12.6	73.3	4.3
Pseudouridine	72.0	6.3	81.3	17.6	67.9	1.7
Hypoxanthine	108.8	9.8	85.9	8.9	93.3	8.1
Xanthine	88.4	5.1	79.7	6.8	84.2	8.8
Uridine	96.3	1.9	84.1	4.0	85.4	1.8
Thymine	88.7	5.2	98.6	9.4	84.0	5.1
Adenine	87.0	6.2	83.4	7.7	102.1	6.1
Inosine	85.6	2.8	78.7	6.1	87.9	5.0
Guanosine	83.2	9.4	71.7	11.3	80.2	2.8
Deoxyinosine	64.3	3.7	60.1	0.4	72.1	5.3
Deoxyguanosine	76.7	7.7	66.8	9.2	75.4	3.5
Thymidine	97.5	2.2	76.5	3.3	83.6	3.2
Adenosine	87.0	2.0	88.4	5.2	86.6	3.3
Deoxyadenosine	90.2	5.9	78.9	3.1	81.2	2.3
Mean	85.3	6.0	79.7	7.5	82.9	4.7

(B)

Compound	50 μ M		150 μ M		250 μ M	
	Rec. (%) [*]	CV (%)	Rec. (%) [*]	CV (%)	Rec. (%) [*]	CV (%)
Uracil	108.0	5.5	104.7	6.8	99.0	0.1
5-OH-methyluracil	75.0	3.6	88.2	6.1	87.8	4.2
Pseudouridine	74.0	5.4	81.2	9.7	89.4	14.4
Hypoxanthine	98.3	5.9	88.6	0.6	96.7	3.1
Xanthine	92.6	6.6	83.9	2.6	92.4	2.6
Uridine	98.7	0.9	100.8	6.1	93.8	7.8
Thymine	99.8	5.5	93.8	4.0	95.6	1.2
Adenine	94.9	9.4	81.7	4.1	92.5	1.5
Inosine	97.0	5.5	89.8	5.7	94.9	0.3
Guanosine	92.9	9.3	87.5	3.3	93.3	0.9
Deoxyinosine	90.8	10.0	82.1	1.2	90.2	2.7
Deoxyguanosine	90.4	9.4	84.2	1.4	92.6	1.2
Thymidine	99.2	4.0	95.6	2.8	97.0	1.9
Adenosine	99.5	3.9	98.7	4.9	97.3	1.0
Deoxyadenosine	93.7	6.1	94.2	4.0	95.7	2.0
Mean	93.7	6.1	90.3	4.2	93.9	3.0

* Mean of three independent solid-phase extractions

* Calculated based on the ratio of area / area internal standard (3-Methyl-guanine)

SPE and HPLC analysis of purines and pyrimidines

Table II. Solid-phase extraction recoveries and reproducibility for a urine supplemented with the various compounds of interest at three different concentrations.

Compound	Urine [*]		Spiked Urine (50 µmol/L)			Spiked Urine (150 µmol/L)			Spiked Urine (250 µmol/L)		
	Mean ^{**} (n=3)	CV (%)	µmol/L	Rec. (%)	CV (%)	µmol/L	Rec. (%)	CV (%)	µmol/L	Rec. (%)	CV (%)
Uracil	53.1	3.0	64.6	63.0	8.4	138.7	68.3	8.0	221.3	73.0	7.7
Hypoxanthine	62.5	3.4	94.5	84.0	2.2	184.9	87.0	6.1	300.2	96.1	4.3
Xanthine	40.0	1.2	76.0	84.4	1.5	189.8	99.9	5.2	277.6	95.7	2.3
Thymine			49.4	98.7	3.4	137.3	91.5	6.1	239.9	95.9	3.0
Adenine			n.d.			n.d.			229.9	92.0	6.2
Inosine			48.9	97.7	5.1	135.9	90.6	6.2	244.1	97.6	4.7
Guanosine			42.9	85.7	2.5	132.5	88.3	7.3	246.7	98.7	1.1
Deoxyinosine			45.5	91.0	7.4	130.1	86.8	6.3	244.7	97.9	8.8
Thymidine			46.7	93.4	4.8	139.1	92.7	6.6	240.2	96.1	6.1
Adenosine			47.1	94.3	5.8	136.4	90.9	6.5	252.0	100.8	0.3
Deoxyadenosine			42.1	84.1	2.8	128.4	85.6	6.7	246.9	98.8	3.0

^{*}Urine without supplementation

^{**}Mean of three independent solid-phase extractions

n.d.-not determined

The intra-assay and the inter-assay precision were evaluated by performing seven independent SPE of the same spiked urine and further submitting to HPLC analysis, three within-day and four between-days, along two weeks. The results are summarised on Table III. The intra-assay and the inter-assay CVs were $\leq 9.2\%$.

In order to evaluate the possible effect of the urine matrix on the SPE efficiency six different urines spiked with the tested compounds (250 µM) were analysed. The recovery was evaluated by comparing spiked and unspiked urine, respectively, submitted to the SPE procedure. As shown on Table IV the recoveries were ≥ 85.7 .

The validity of the method was also demonstrated by analysing urine samples from patients with established diagnosis: purine nucleoside phosphorylase deficiency; molybdenum-cofactor deficiency; dihydropyrimidine dehydrogenase deficiency and adenylosuccinate lyase deficiency. The chromatograms are displayed in Fig. 3.

Chapter 3

Table III. Intra-assay and inter-assay variation of the SPE and the chromatography analysis.

Compound	Intra-assay ^a		Inter-assay ^b	
	$\mu\text{mol/L}^c$	CV(%)	$\mu\text{mol/L}^c$	CV(%)
Hypoxanthine	302.8	2.3	300.9	3.5
Xanthine	275.5	2.8	277.1	1.9
Thymine	243.8	0.8	240.9	2.6
Adenine	227.8	5.8	229.4	5.1
Inosine	259.8	4.8	248.0	4.9
Guanosine	251.8	1.3	248.0	1.4
Deoxyguanosine	242.0	9.2	242.5	7.5
Thymidine	229.1	7.8	237.4	5.5
Adenosine	250.3	1.5	251.6	0.4
Deoxyadenosine	252.4	1.7	248.3	2.7

a, b - the same urine sample spiked with the studied compounds at a final concentration of 250 mol/L was submitted to SPE in the same day (n=3) or on different days (n=4) over 2 weeks.

c - Final concentration detected (urine blank plus added compounds)

Table IV. Accuracy of SPE and the chromatography analysis in urines.

Compound	Spiked urines ^a (n=6)	
	Rec (%) ^b	CV(%)
Hypoxanthine	112.0	18.5
Xanthine	113.9	20.8
Thymine	90.3	8.3
Adenine	92.8	19.4
Inosine	93.6	9.0
Guanosine	99.8	10.4
Deoxyinosine	95.2	10.0
Thymidine	85.7	15.0
Adenosine	98.0	6.6
Deoxyadenosine	94.9	10.5

a Spiked with 250 $\mu\text{mol/L}$ each studied compound

b Mean of 6 different urines which were supplemented and submitted to SPE

SPE and HPLC analysis of purines and pyrimidines

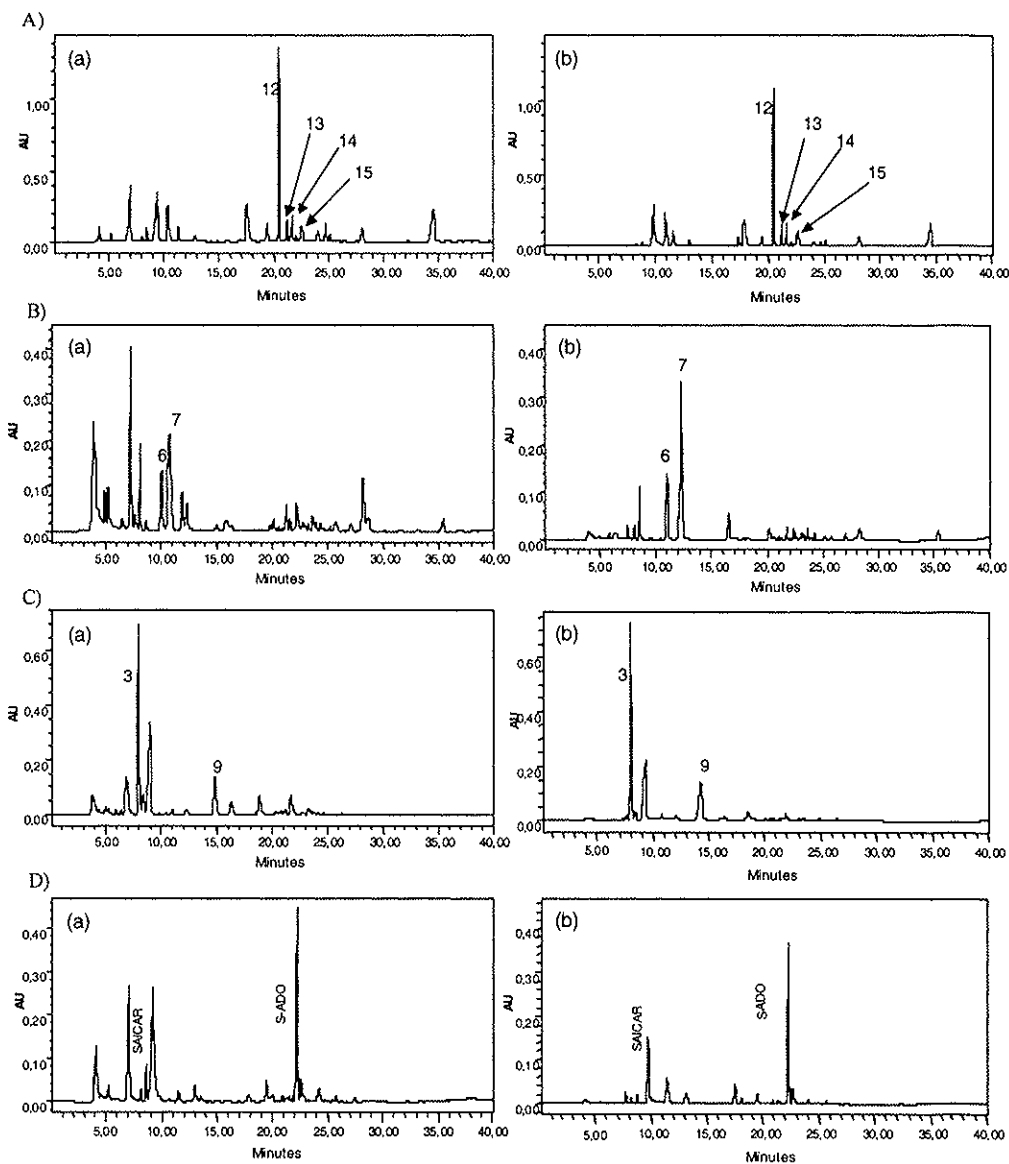

Fig. 3 – Chromatograms of purine and pyrimidine metabolites in urines before (a) and after (b) SPE from: A) a patient with PNP deficiency; B) a patient with Mo-cofactor deficiency; C) a patient with DHPD deficiency; D) a patient with ADSL deficiency. Peak identity is the same as in Fig. 1.
PNP: purine nucleoside phosphorylase; Mo: molybdenum; DHPD: dihydropyrimidine dehydrogenase; ADSL: adenylosuccinate lyase; S-ADO: succinyladenosine; SAICAR: succinylaminoimidazole carboxamide riboside.

4. DISCUSSION

The analysis of urinary purine and pyrimidine profiles has been successfully used for the screening of the distinct pathologies associated with impaired metabolism of those compounds. Different methods based on chromatographic techniques have been used for that purpose although their suitability is often dependent on the type of sample to be analysed. Several diet and drug metabolites, which contribute for the majority of the interfering compounds, may make it difficult or even impossible to identify the compounds of interest as well as to quantify correctly, specially at moderately increased levels. For these reasons, in general, sample pre-treatment is required in order to improve the qualitative and quantitative analysis.

We describe a new SPE method, using an anion-exchange matrix, for extraction of urine purine and pyrimidine metabolites. The method has shown good recoveries, higher than 80%, as well as a high reproducibility with CVs lower than 10% for the majority of the studied compounds, at low and high levels, either for mixtures of standards in aqueous solution or for urine samples spiked with different amounts of the authentic compounds. Additionally, at normal or moderately increased levels, the similarity of urine metabolites spectra to the respective pure standards spectra were clearly improved, enabling the unequivocal identification of compounds. The effectiveness of the SPE procedure, in the removal of the interfering compounds which co-elute on the further HPLC analysis have, thus, been proved. Furthermore, the quantitative analysis accuracy also increases, not only due to the removal of the co-eluting peaks but also owing to the fact that the internal standard behaviour over the SPE procedure is identical to that of the tested compounds, enabling correction for possible losses along the extraction process.

In conclusion, the SPE method is a simple one, not time-consuming and it can be used for screening purposes or for the quantification of specific metabolites at low or moderately increased levels, which are relevant in the follow-up of patients under treatment.

REFERENCES

- [1] Simmonds HA, Duley JA, Fairbanks LD, McBride MB. When to investigate for purine and pyrimidine disorders. Introduction and review of clinical and laboratory indications. *J Inher Metab Dis*, 20 (1997) 214-226.
- [2] Simmonds HA, Duley JA, Davies PM, Frits A. Hommes (Editor). Analysis of purines and pyrimidines in blood, urine and other physiological fluids. In: *Techniques in diagnostic human biochemical genetics*, John Wiley & Sons Inc., 1991, p. 397-424.
- [3] Duran M, Dorland L, Meuleman EEE, Allers P, Berger R. Inherited defects of purine and pyrimidine metabolism: Laboratory methods for diagnosis. *J Inher Metab Dis*, 20 (1997) 227-236.
- [4] Esmans EL, Broes D, Hoes I, Lemièrre F, Vanhoutte K. Liquid chromatography-mass spectrometry in nucleoside, nucleotide and modified nucleotide characterization. *J Chromat A*, 794 (1998) 109-127.
- [5] Van Lenthe H, Van Kuilenburg ABP, Ito T, Bootsma A, Van Cruchten A, Wada Y, Van Gennip AH. Defects in pyrimidine degradation identified by HPLC-Electrospray Tandem Mass Spectrometry of urine specimens or urine-soaked filter paper strips. *Clin Chem*, 46:12 (2000) 1916-1922.
- [6] Ito T, Van Kuilenburg ABP, Bootsma A, Haasnoot AJ, Van Cruchten A, Wada Y, Van Gennip AH. Rapid screening of high-risk patients for disorders of purine and pyrimidine metabolism using HPLC-electrospray tandem mass spectrometry of liquid urine or urine-soaked filter paper strips. *Clin Chem*, 46:4 (2000) 445-452.
- [7] Walker V, Mills GA. Solid-phase extraction in clinical biochemistry. *Ann Clin Biochem*, 39 (2002) 464-477.

Chapter 3

- [8] Morris GS and Simmonds HA. Use of a fundamental protocol for the development of reversed-phase high-performance liquid chromatography enabling rapid simultaneous determination of purines, pyrimidines and allied compounds commonly found in human biological fluids. *J Chromat*, 344 (1985) 101-113.
- [9] Evans JE and Tieckelmann H. Measurement of urinary pyrimidine bases and nucleosides by high-performance liquid chromatography. *J Chromat*, 163 (1979) 29-36.
- [10] Rivera IA, Tavares de Almeida I and Silveira C. A single HPLC system for the evaluation of purine and pyrimidine metabolites in body fluids. *Adv Exp Med Biol*, 309B (1991) 11-14.

**URIC ACID AND CREATININE LEVELS IN TWO GROUPS OF
SCHOOL CHILDREN.**

**Helena Caldeira Araújo, Helena Silva, Rui Ornelas, Helena Tomás,
Isabel Tavares de Almeida and Marinus Duran.**

Submitted for publication in *Pediatric Nephrology*.

ABSTRACT

Uric acid and creatinine are good diagnostic parameters for several diseases. However, their assessment implies previous knowledge of each population's reference ranges.

The objective of this study was to determine the normal levels of uric acid and creatinine in plasma and urine of local healthy children and adolescents as well as to evaluate their urinary uric acid to creatinine ratios. A total of 333 individuals (166 males and 167 females) from two age groups (9 and 15 years) were investigated. The plasma concentrations of uric acid and creatinine suffered an increase with age ($P < 0.001$) and sex-related differences were observed in the older groups ($P < 0.001$). Excretion rates of uric acid did not differ significantly with age or sex whereas those of creatinine increased significantly with age ($P < 0.001$) and have shown to be higher in males than females in the older group ($P < 0.05$). The urinary uric acid to creatinine ratio decreased significantly with age ($P < 0.001$) and varied significantly between sexes in both age groups ($P < 0.05$). Children with plasma uric acid or urinary ratios higher or lower than 2SD showed no abnormalities of purine metabolism. This report provides evidence of sex and age influences in uric acid, creatinine and urinary uric acid to creatinine ratios.

INTRODUCTION

Uric acid is the end product of human purine metabolism. Its production depends on the purine nucleotide pool i.e. on the purine synthesis *de novo*, the amount of dietary purines and from nucleotide interconversion and degradation reactions (purine *salvage*). About two thirds of the daily production of uric acid is excreted by the kidney. The renal excretion depends on the serum uric acid concentration, this last being a function of the degradative and synthetic rates [1,2].

Although uric acid is not a specific disease marker it brings us information about several disorders, such as, inherited deficiencies of purine metabolism, disorders of fatty acid oxidation, disorders of carbohydrate metabolism, malignancy, preeclampsia and renal disorders. Moreover, uric acid levels can be easily and rapidly evaluated [1,2,3,4].

The use of uric acid concentrations in blood and urine requires the establishment of control ranges for healthy children and adults as it may vary considerably among different populations, being influenced by age, sex

and diet [5]. The urine concentration is usually related to that of creatinine, thereby making a comparison between individuals more reliable. Urine creatinine excretion parallels its endogenous production and the daily excretion rate is relatively constant (c.v. 1.7%) when the renal function is not impaired.

Creatinine is produced from the non-enzymatic dehydration of muscle creatine. Free creatinine is not reutilised in the body's metabolism and thus functions as a waste product of creatine. Inter-individual variations of creatinine excretion in healthy people are attributable mainly to age, sex and muscle mass [6].

Because creatinine is released from the tissues into body fluids at a constant rate, both plasma concentration and creatinine clearance are widely used markers of renal function, in particular of the glomerular filtration rate (GFR). Recently, creatinine has also shown to be an important biochemical parameter for the diagnosis of creatine biosynthesis defects [7].

The urinary uric acid to creatinine ratio has been frequently used as a screening test for disorders of purine metabolism [8,9]. In addition, uric acid levels are dependent on nucleotide interconversion rates and may be increased in malignancy, severe infections or conditions associated with trapping of phosphate such as fructose-1-phosphate aldolase deficiency (hereditary fructose intolerance). Recently it has shown to be useful as an alerting signal for the presence of creatine biosynthesis defects, as well [10]. The aim of our study was to determine the plasma and urinary uric acid and creatinine levels as well as the urinary uric acid / creatinine ratio, in two different age groups of local healthy schoolchildren, in order to establish reference values and allow the screening of children at risk by comparison with normal ranges. The changes of these values associated with the start of accelerated growth of puberty were recorded.

SUBJECTS AND METHODS

Subjects

A total of 333 healthy schoolchildren (166 males and 167 females) of two different age groups, a pre-pubertal 9-year-old group (81 males and 75 females) and a pubertal 15-year-old group (85 males and 92 females) were recruited from several schools of Madeira Island. Schools were selected from different areas of the island so that the various ethnic and socio-economic groups were equally represented. All the subjects were Caucasian and we aimed to recruit no more than 6 children per day. Children were told not to change their eating habits or their physical activity. Parents were informed that the first morning urine should be collected and that children shouldn't eat or drink until arrival at the laboratory.

Acute or chronic illness were used as exclusion criteria. Participation in the study took place after written parental consent.

Methods

Sample collection

The first morning urine was collected at home, between 6.00 and 7.30 AM, in sterile, chemically clean flasks and was brought to the laboratory.

Overnight fasting blood samples were collected by venipuncture in lithium heparinate containing tubes between 8.00 and 9.30 AM. Half an hour later the samples were centrifuged at 1600 g for 12 min and the plasmas were separated. Urines and plasmas were analysed for uric acid and creatinine within 3 hours after collection.

A report was made for each child which included personal information (name, address, date of birth, contact) and information about occasional medication and purine-enriched diet on the previous two days.

Uric acid and creatinine analysis

Creatinine was measured by a kinetic Jaffé method without deproteinisation (Boehringer Mannheim, Germany) in which creatinine reacted with picrate in alkaline solution to form a coloured complex.

Uric acid was measured by an enzymatic colorimetric test using uricase (Boehringer Mannheim, Germany). Uric acid was oxidized by uricase to form allantoin and hydrogen peroxide. The latter product was measured by a colorimetric assay and was proportional to the uric acid concentration.

All the tests were performed on a Hitachi 912 analyser (Boehringer Mannheim, Germany) according to the instructions of the manufacturer.

Plasma uric acid and creatinine and their respective urinary excretion were all expressed in mmol/L. Values for urinary uric acid to creatinine ratios were expressed as molar ratios.

Statistical analysis

The 95% confidence limits for plasma and urinary uric acid and creatinine and for urinary uric acid / creatinine ratios were constructed from $t_{0.05}$ SEM above and below the mean, by age and sex.

Student's *t* test was used to compare the observed concentrations between boys and girls and between the two age groups in each sex.

RESULTS

Uric acid

Plasma uric acid increased with age in both gender (Table 1). The mean values displayed a statistically significant increase from 0.226 to 0.332 mmol/L in boys and 0.226 to 0.255 mmol/L in girls both ($P < 0.001$). There was no sex-related difference in the 9-year-old groups, however, for the 15

Uric acid and creatinine levels in Madeira school children

year-old groups a significantly higher value was observed for boys when compared to girls ($P < 0.001$).

Uric acid excretion rates did not increase with age in either sex (Table 2). Comparison of boys and girls of the same age groups did not show statistically significant differences.

Table 1. Serum uric acid and creatinine in normal school children for two different age groups.

Plasma	Age (years)	Boys		Girls	
		Mean (mmol/L)	95% confidence limits	Mean (mmol/L)	95% confidence limits
Uric acid	9	0.226	0.216-0.236	0.226	0.215-0.237
	15	0.332	0.316-0.348	0.255	0.244-0.266
Creatinine	9	0.0619	0.0606-0.0632	0.0610	0.0597-0.0622
	15	0.0784	0.0766-0.0802	0.0704	0.0690-0.0718

Creatinine

As it can be seen from Table 1, there was a significant increase of mean plasma creatinine with age, both in boys and in girls ($P < 0.001$). Analogous to plasma uric acid, there was no statistic difference between 9-year-old boys and girls, but for the older group the difference was significant ($P < 0.001$), with higher mean values in the boys.

The excretion of creatinine increased significantly with age, in boys and in girls ($P < 0.001$). There was no statistical difference between the two sexes

Chapter 4

at age 9 but at age 15 the excretion was significantly higher in boys ($P < 0.05$).

Ratio

The mean urinary uric acid / creatinine ratios decreased significantly with age from 0.429 to 0.286 in boys and 0.389 to 0.316 in girls ($P < 0.001$). The difference between boys and girls of both age groups was statistically significant ($P < 0.05$).

Table 2. Urinary uric acid, creatinine and uric acid/creatinine ratio in normal school children for two different age groups

Urine	Age (years)	Boys		Girls	
		Mean (mmol/L)	95% confidence limits	Mean (mmol/L)	95% confidence limits
Uric acid	9	3.28	2.98-3.58	3.06	2.74-3.38
	15	3.51	3.20-3.82	3.47	3.18-3.76
Creatinine	9	7.86	7.18-8.54	7.96	7.22-8.70
	15	12.78	11.65-13.91	11.27	10.37-12.17
Ratio	9	0.429	0.404-0.454	0.389	0.360-0.418
	15	0.286	0.268-0.304	0.316	0.297-0.335

DISCUSSION

Uric acid and creatinine are routine clinical chemistry parameters which give valuable diagnostic clues to several disorders. However, the use of uric acid concentrations, for correct diagnosis of underlying abnormalities,

requires a combination of blood and urine values and also the study of the local reference ranges since they are influenced by the dietary purine intake [5].

In our study we aimed to establish reference values for these parameters in blood and urine of school children and young adolescents. Plasma uric acid increased with age in both gender, as would be expected from previous reports, possibly due to a substantial increase in body mass. An increase of excretion by the kidney, with age, would also be expected [1,2] but in our case there was no significant increase.

Mean plasma and urine creatinine increased significantly with age both in boys and in girls reflecting the increase in muscle mass. There was no significant difference in boys and girls of the 9-year-old group but, in the 15-year-old group, boys showed a higher plasma creatinine and a higher urinary excretion than girls, possibly related to an increased muscle mass. Increased creatinine excretion with age has been reported [11].

The mean urinary uric acid / creatinine ratios were slightly higher in boys than in girls of the 9-year-old group ($P < 0.05$), although there was no significant difference between the excretion of uric acid and creatinine between the two gender. The ratios decreased with age in boys and in girls due to the increase of creatinine excretion in both sexes, since the uric acid excretion didn't increase significantly with age. In the 15-year-old group the urinary ratio was lower in boys than in girls due to their higher excretion of creatinine. Previous studies have reported a decrease with age of the ratio values but sex-related differences were not evaluated [8,12].

Our study has included a larger group of children with the same age than previous studies. This has shown the distribution of the uric acid and creatinine values to be narrower spaced than was previously thought.

The urinary uric acid / creatinine ratios in the Madeira school children were lower than those reported by Matos et al [12], who studied Swiss children of different age groups. One may speculate on the different dietary habits in the two populations as a causing factor for these discrepancies. A general lower uric acid / creatinine ratio would diminish the potential risk of uric acid nephropathy. Further dietetic studies are needed to elucidate this pattern.

Chapter 4

Children with mean urinary ratios or plasma uric acid values, higher or lower than 2 standard deviations from the mean, were screened for purine metabolism disorders by analysing their plasma and urine purine profiles by HPLC/UV diode array detection. None of them showed any abnormalities. These urinary ratios are considered to be of high importance in the screening of several disorders of purine metabolism and recently of disorders of creatine biosynthesis defects. Their interpretation requires the correlation with serum uric acid for the first group of disorders and with serum creatinine in the latter group. The establishment of reference values for each population is though extremely important for a correct interpretation.

ACKNOWLEDGEMENTS

The authors thank *Secretaria Regional dos Assuntos Sociais da Madeira* who authorized the use of equipment to analyse the samples. We also thank the personnel from the Biochemistry Division of *Laboratório de Saúde Pública* for their valuable help.

REFERENCES

- [1] Sperling O (2001) Hereditary renal hypouricemia. In: Scriver, Beaudet, Valle, Sly (eds) *The Metabolic and Molecular Basis of Inherited Disease*. McGraw Hill, New York, p. 5069-5083.
- [2] Wilcox, WD (1996) Abnormal serum uric acid levels in children. *J Pediatr* 128: 731-741.
- [3] Kharb S, Singh GP (2001) Hyperuricemia, oxidative stress in preeclampsia. *Clin Chim Acta* 305: 201-203.

Uric acid and creatinine levels in Madeira school children

- [4] Mayatapek E, Koch HG, Hoffmann GF (1997) Hyperuricaemia and medium-chain acyl-CoA dehydrogenase deficiency. *J Inherit Metab Dis* 20: 842-843.
- [5] Simmonds HA, Duley JA, Fairbanks LD, McBride MB (1997) When to investigate for purine and pyrimidine disorders. Introduction and review of clinical and laboratory indications. *J Inher Metab Dis* 20:214-226.
- [6] Pincus MR, Preuss H, Henry JB (1996) Evaluation of renal function, water, electrolytes, acid-base balance, and blood gases. In: Henry (ed) *Clinical Diagnosis and Management by Laboratory Methods*. W.B. Saunders Company, Philadelphia, p. 162-407.
- [7] Wyss M and Kaddurah-Daouk (2000) Creatine and creatinine metabolism. *Physiological Review* 80 (3): 1107-1213.
- [8] Kaufman JM, Greene ML, Seegmiller JE (1968) Urine uric acid to creatinine ratio-a screening test for inherited disorders of purine metabolism. *J Pediatr* 73 (4): 583-592.
- [9] Duran M, Dorland L, Meuleman EEE, Allers PJ and Berger R (1997) Inherited defects of purine and pyrimidine metabolism: laboratory methods for diagnosis. *J Inherit Metab Dis* 20: 227-236.
- [10] Caldeira Araujo H, Smit W, Verhoeven NM, Tomas H, Silva S, Vasconcelos R, Tavares de Almeida I, Jakobs C and Duran M (2002) Urinary uric acid vs creatinine as a screening tool for GAMT deficiency. *J Inherit Metab Dis* 25 (Supl 1): 145.
- [11] Skinner AM, Addison GM, Price D (1996) Changes in the urinary excretion of creatinine, albumin and N-acetyl- β -D-glucosaminidase with increasing age and maturity in healthy schoolchildren. *Eur J Pediatr* 155: 596-602.

Chapter 4

- [12] Matos V, Van Melle G, Werner D, Bardy D, Guignard JP (1999) Urinary oxalate and urate to creatinine ratios in a healthy pediatric population. *Am J Kid Dis* 34(2): 1-6.

PART III

METABOLIC SCREENING OF PURINES AND CREATINE

**URINARY URIC ACID / CREATININE RATIO AS A SCREENING
TOOL FOR CREATINE BIOSYNTHESIS DEFECTS.**

Helena Caldeira Araújo, Helena Tomás, Saturnino Silva, Rui Vasconcelos, Wilma Smit, Isabel Tavares de Almeida and Marinus Duran.

Submitted for publication in *Annals of Clinical Biochemistry*.

ABSTRACT

Background: The urinary uric acid to creatinine ratio has long been used as a screening test, first for conditions of uric acid overproduction such as malignancies and the Lesch-Nyhan syndrome and, more recently, also for other disorders of purine metabolism. The uric acid / creatinine ratio may also be changed by a decreased endogenous creatinine production rate. **Methods:** 174 patients (81 males and 93 females) aged between 6 and 36 years, from an institution for the mentally retarded, were analysed for uric acid and creatinine in plasma and urine, as part of a screening programme for defects of purine and pyrimidine metabolism. As an additional analysis of individual purines gave negative results, subsequent analysis of guanidinoacetic acid in urine and plasma was done by stable isotope dilution gas chromatography / mass spectrometry. **Results:** The high urinary uric acid to creatinine ratio in one female patient with a normal uricaemia was the first indication of a decreased creatinine production. This led us to measure the guanidinoacetic acid excretion in six patients, which presented a high ratio vs. low creatinine in urine. Four of these patients had increased levels of the creatine biosynthesis intermediate, which clearly indicated guanidinoacetic acid methyltransferase (GAMT) deficiency. **Conclusions:** An increased urinary uric acid to creatinine ratio is a useful alerting signal for the presence of creatine biosynthesis defects. The plot of uric acid / creatinine vs. creatinine in the urine gives the best discrimination.

INTRODUCTION

Uric acid is the end metabolite of purine nucleotide catabolism. It cannot be utilised by the human and is removed from the organism by its excretion into the urine. The amount of uric acid produced depends on several factors, i.e. endogenous *de novo* synthesis of nucleotides, ingestion of nucleotides from the diet, and re-synthesis of nucleotides from hypoxanthine and phosphoribosyl pyrophosphate by the so-called salvage pathway catalysed by the enzyme hypoxanthine phosphoribosyl transferase (HPRT). *De novo* synthesis is activated by the amount of available phosphoribosyl

pyrophosphate (PRPP). Hence a deficiency of HPRT, the enzyme involved in the Lesch-Nyhan syndrome (1), not only results in a diminished salvage of nucleotides and excessive production of uric acid, but also to an enhanced *de novo* synthesis of nucleotides through the excess of PRPP not utilised by HPRT. These newly formed nucleotides are eventually broken down to uric acid again.

Accumulating uric acid can be measured both in serum and urine. The renal tubular reabsorption of uric acid is effected by a specific carrier. Defective functioning of this carrier will lead to a genetic disease called hyperuricosuria (2), accompanied by low plasma urate levels. Also generalised defects of renal tubular function such as those observed in cystinosis ('renal Fanconi syndrome') may lead to excessive hyperuricosuria.

Diminished production of uric acid may be the result of several enzyme deficiencies, such as, xanthine dehydrogenase (3) and purine nucleoside phosphorylase (4). These conditions lead to both hypouricaemia and hypouricosuria.

A secondary hyperuricosuria and hyperuricaemia may be observed in inherited defects such as glycogen storage disease type I, hereditary fructose intolerance, and medium-chain acyl-CoA dehydrogenase deficiency. Hyperuricaemia and hyperuricosuria can also be found in situations such as preeclampsia and malignancy due to enhanced tissue turnover (5, 6).

Both plasma and urine uric acid assays are important for the interpretation of the uric acid homeostasis. For reasons of convenience the urine uric acid is often not expressed as mmol/24 hr but is related to the urine creatinine value. Creatinine is excreted in a constant manner and is only dependent on the muscle mass. It is the non-enzymatic breakdown product of creatine (phosphate), the key substance in energy production (7). Creatine is synthesised from the amino acid arginine in a two-step process, involving the enzymes arginine:glycine aminotransferase (AGAT) and guanidinoacetic acid methyltransferase (GAMT). Defects of both enzymes have recently been identified (8, 9). The former defect gives rise to a decreased production of guanidinoacetate, the latter defect results in excessive guanidinoacetate excretion. A quantitative analysis of

guanidinoacetate requires a stable isotope mass spectrometric approach, which is available in highly specialised laboratories, only. Here we describe the usefulness of the urine uric acid / creatinine ratio, together with plasma uric acid and creatinine, for the first screening of patients with a suspicion of creatine biosynthesis defects. Screening results of a population of 174 patients in an institution for the mentally retarded revealed four new patients with a deficiency of GAMT.

Part of our findings were presented in abstract form (10).

METHODS

Population

A screening programme was carried out in a total of 174 patients (children, adolescents and adults) aged between 6 and 36 years (81 males and 93 females), from an institute of mentally retarded and socially unadapted patients. All patients originated from the island of Madeira, a relatively small (245.000) and isolated community.

Samples

The first morning urine was collected between 7.00 and 8.30 AM. Non-toilet-trained patients had 2 random urine samples collected between 7.00 and 12.00 AM, in adhesive urine collecting bags. Overnight fasting blood samples were collected by venipuncture between 7.00 and 8.30 AM.

All patients had the same equilibrated diet, supplied by the institution and took the appropriate medications according to their disease / symptoms. A report was made for each patient which included personal information (name, address, date of birth) and information about first symptoms, diagnosis and medication.

Sample analysis

Urine samples were collected in sterile and chemically clean flasks (or sterile bags and transferred to flasks) and blood samples were collected in lithium heparinate containing tubes. They were all brought to the laboratory;

Chapter 5

blood samples were immediately centrifuged at 1600 g for 12 min and the plasmas were then separated. Urines and plasmas were analysed for uric acid and creatinine within 2 hours after collection.

Creatinine in urine and plasma was measured by a kinetic Jaffé method without deproteinisation (Boehringer Mannheim, Germany) and uric acid was measured by an enzymatic colorimetric test using uricase (Boehringer Mannheim, Germany). These tests were performed on a Hitachi 912 analyser (Boehringer Mannheim, Germany) according to the instruction of the manufacturer.

Values for urine uric acid to creatinine concentration ratio are reported as molar ratios. Each urine sample was analysed for purines and pyrimidines by reversed-phase HPLC in order to rule out primary inherited defects in this area (data not shown here).

The subsequent analysis of guanidinoacetic acid (GAA) in urine and plasma was done by stable isotope dilution gas chromatography / mass spectrometry, mainly as described by Hunneman and Hanefeld (11). The GAA of the 90 μL samples was converted to N-bis-4,6-(trifluoromethyl)pyrimidinyl-aminoacetic acid by reaction with hexafluoro-acetylacetone in toluene at 80°C for 16 hours. Then the carboxygroup of the latter product was converted to the tert-butyl-dimethylsilyl ester by the addition of 12.5 μL N'-methyl-N-(tert-butyl-dimethylsilyl)trifluoroacetamide (MTBSTFA) to 50 μL of the upper toluene layer, giving the tert-butyl-dimethylsilyl-N-bis-4,6(trifluoromethyl-pyrimidinyl)-aminoacetate derivative.

Quantitative determination of GAA with 1,2- $^{13}\text{C}_2$ -GAA (purchased from dr. H.J. ten Brink, VU Medical Center, Amsterdam) as internal standard, was then carried out by gas chromatography / mass spectrometry (GC/MS) with selected ion monitoring using the GC/MS in the electron impact mode, focussed on the (M-57)-fragments of the analyte and the internal standard, i.e. m/z 346 and 348.

RESULTS

The screening programme for inherited metabolic disease in the institute for mentally handicapped included a search for defects of purine and pyrimidine metabolism (12). As a first approach we used the urine uric acid / creatinine ratio in order to pinpoint hyper/hypouricosuria. Reference values for uric acid and creatinine were calculated by analysing urine samples from 350 healthy school children aged 9 and 15 years (Caldeira Araújo et al., to be published). For the 15 year old subjects uric acid / creatinine ratios (mol/mol) of 0.29 ± 0.09 (male) and 0.32 ± 0.09 (female) were calculated. As expected, the younger children had somewhat higher uric acid / creatinine ratios, for 9 year old boys this was 0.43 ± 0.11 mol/mol and for the girls we found 0.39 ± 0.13 .

Consequently we used the highest excretion levels of uric acid / creatinine as a cut-off for our screening, i.e. 0.65 mol/mol for both males and females. When applying these cut-off values to the set of patients selected for screening, 3 male patients fell out with an increased uric acid / creatinine and six female patients had an abnormal uric acid / creatinine ratio (Fig. 1A and 1B). The plasma uric acid of all these patients was entirely normal ranging from 0.17 to 0.27 mmol/L (controls 0.12-0.36) and no abnormalities of the purine and pyrimidine profiles were found, after HPLC / UV diode array analysis, of urines and plasmas (13). Subsequently we correlated the uric acid / creatinine ratios with the respective urine creatinine concentrations (mmol/L). Figs. 1A and 1B show that two female patients (patient 1 and 2) and one male patient (patient 3) had a lowered creatinine output in addition to their uric acid / creatinine ratios in the upper normal range. Finally three additional patients with the highest uric acid / creatinine ratio and the lowest creatinine per se had their plasma creatinine measured. This resulted in one more patient (patient 4) with a decreased plasma creatinine of 34 μ mol/L and two patients with normal plasma creatinine of 62 and 111 μ mol/L respectively (controls 35-122).

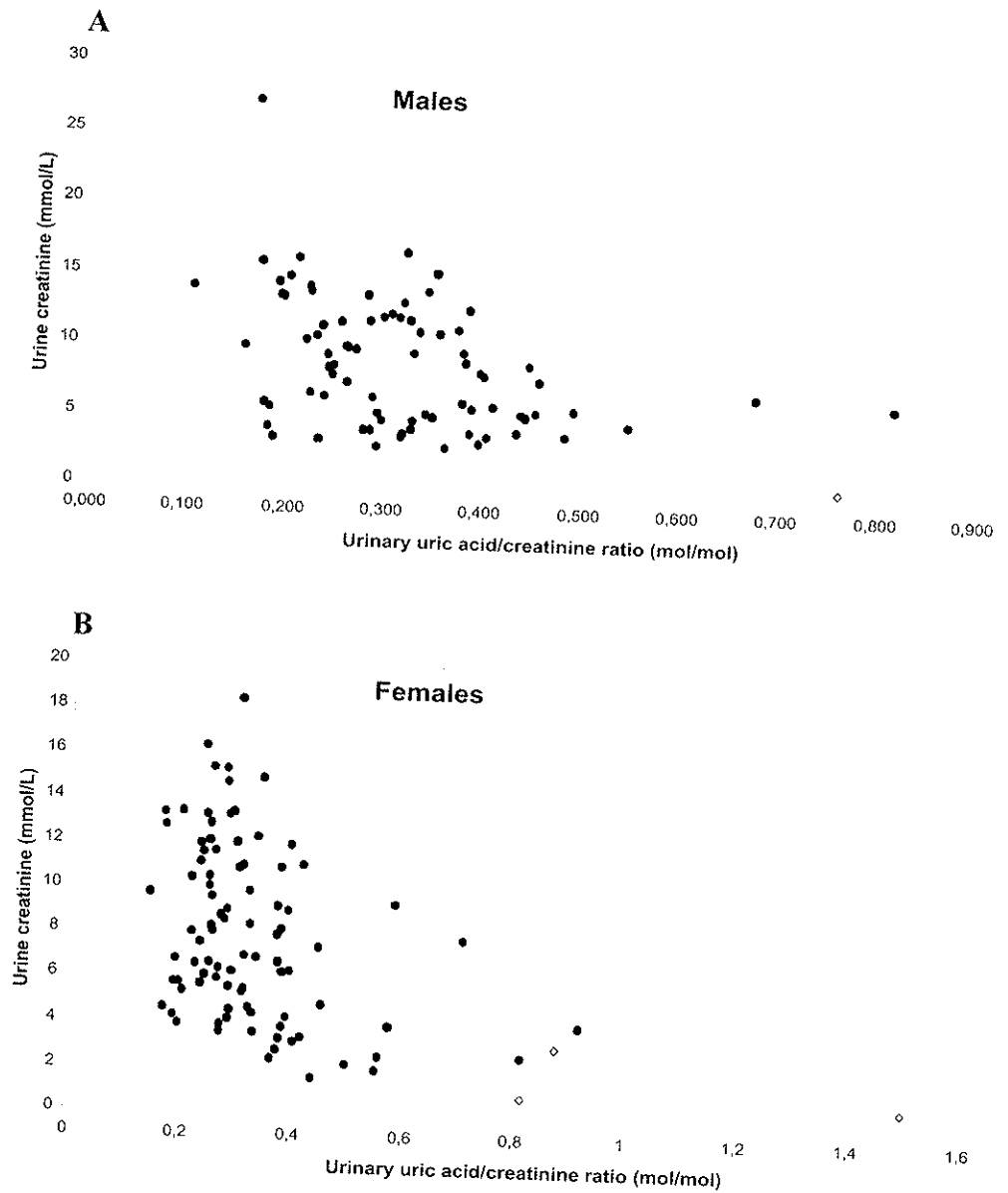

Fig. 1 - Relationship between the urinary excretion of creatinine (mmol/L) and the urinary uric acid / creatinine ratio (mol/mol) in a population of 81 male (A) and 93 female (B) patients of an institute for mentally handicapped patients. Patients with GAMT-deficiency are indicated (\diamond).

Urinary uric acid to creatinine ratio in GAMT deficiency

All urine samples with positive or doubtful abnormalities were analysed for guanidinoacetic acid. Patients 1-4 had increased levels of this creatine biosynthesis intermediate ranging from 347-1624 mmol/mol creatinine (controls <150), which was a clear evidence of guanidinoacetic acid methyltransferase deficiency (Table 1). In addition their plasma GAA levels were strikingly elevated, more than tenfold in comparison with the upper normal range (Table 1).

Table 1. Laboratory investigation of urines and plasmas of the four patients and controls

Metabolite (urine)	Patient 1	Patient 2	Patient 3	Patient 4	Controls
Uric acid (mmol/L)	1.03	0.75	0.33	2.77	2.18-5.43
Creatinine (mmol/L)	0.68	0.92	0.43	3.15	2.48-22.9
Ratio (mol/mol)	1.50	0.82	0.77	0.88	< 0.65
Guanidinoacetate (mmol/mol creat.)	614	742	347	1624	<150

Metabolite (plasma)	Patient 1	Patient 2	Patient 3	Patient 4	Controls
Creatinine (mmol/L)	33	37	18	34	35-122
Guanidinoacetate (µmol/L)	17	26	20	27	< 1.5

All other tested patients had GAA levels below 100 mmol/mol creatinine, and were thus considered to have a normal creatine biosynthesis. Especially no decreased GAA values were observed, excluding a deficiency of arginine:glycine aminotransferase, the GAA-forming enzyme. Subsequent assays of guanidinoacetate methyltransferase in lymphoblasts confirmed the deficiency of this enzyme (data not shown).

DISCUSSION

The use of the urine uric acid to creatinine ratio as a screening test for inherited disorders of purine metabolism has been advocated as long as 35 years ago (14). At that time the attention was focused mainly on the Lesch-Nyhan syndrome, but several other applications have been found later (12, 13).

Uric acid excretion by the kidneys is a four-step-process involving: a) filtration of urate by the glomerulus, b) virtually complete reabsorption in the proximal tubules, c) active secretion in the terminal part of the proximal tubule, and d) partial reabsorption distal to the secretory site.

Hyperuricosuria in the absence of hyperuricaemia may be the consequence of a renal uric acid transport defect. This condition is usually associated with hypouricaemia. None of our patients had a clearly increased or decreased plasma uric acid level, however (data not shown). Also secondary causes of uric acid overproduction such as malignancies with increased nucleotide turnover or disturbances of carbohydrate metabolism leading to excessive nucleotide breakdown were highly unlikely. Finally we could not find indications of drug treatment or a renal Fanconi syndrome which might be held responsible for an increased renal output of uric acid.

As we dealt with institutionalised patients with very severe mental handicaps, it was virtually impossible to collect 24-hour urine samples. Hence the evaluation of the urate excretion was solely based on a comparison with that of creatinine.

The excretion of creatinine is primarily determined by the glomerular filtration rate. When no changes of the glomerular function occur, its excretion is expected to be constant. The daily amount of creatinine reflects the total muscular mass as creatinine is non-enzymatically produced from creatine and creatine phosphate. It is generally accepted to relate the urine excretion rate of metabolites with that of creatinine, thereby obtaining comparable values between individuals.

We have demonstrated that an increased urine uric acid / creatinine ratio may be a first indication of a decreased creatine production. Two enzyme defects in the creatine biosynthetic pathway have been identified recently, i.e. arginine: glycine aminotransferase deficiency (9) and guanidinoacetate methyltransferase deficiency (8).

The quantitative analysis of guanidinoacetate in urine and plasma is the logical next diagnostic step. Urine uric acid / creatinine ratios, as such, do not always reveal all patients with GAMT-deficiency. As can be seen from Figs 1A and 1B the best discriminating factors were found in plotting the urine uric acid / creatinine vs. the urine creatinine. Plasma creatinine measurements may be informative although formally spoken not all GAMT-deficient patient have decreased values (Table 1). In this respect it is important to have one's own reference values, because these are highly method-dependent (15).

All samples with 'high' uric acid / creatinine values (>0.7) should be checked for the presence of abnormal values of guanidinoacetate. The latter assay requires specialised stable isotope dilution GC/MS analyses, which are only available in dedicated biochemical genetics laboratories. A correct diagnosis is essential because creatine biosynthesis defects are now regarded as treatable disorders (16). Analysis of urinary purines and pyrimidines – including uric acid – has long been recognised as a useful tool in the diagnostic package available for genetic metabolic disorders. The usefulness of these analyses may now be extended to defects of creatine biosynthesis which are clinically characterized by severe mental retardation, variable seizures and absence of speech development.

REFERENCES

- [1] Nyhan WL. The recognition of Lesch-Nyhan syndrome as an inborn error of purine metabolism. *J Inherit Metab Dis* 1997; 20: 171-178.
- [2] Watanabe T, Abe T and Oda Y. Exercise-induced acute renal failure in a patient with renal hypouricemia. *Pediatric Nephrol* 2000; 14(8-9): 851-852.
- [3] Wilson ML. Purine nucleoside phosphorylase deficiency. *Adv Exp Med Biol* 1974; 41: 343-349.
- [4] Markert ML. Purine nucleoside phosphorylase deficiency. *Immunodeficiency Rev* 1991; 3: 45-81.
- [5] Geene HL, Wilson FA, Hefferan P, Terry AB, Moran JR, Slonim AE, et al. ATP depletion, a possible role in the pathogenesis of hyperuricemia in glycogen storage disease type I. *J Clin Invest* 1978; 68: 321-328.
- [6] Wilcox WD. Abnormal serum uric acid levels in children. *J Pediatr* 1996; 128: 731-741.
- [7] Wyss M and Kaddurah-Daouk. Creatine and creatinine metabolism. *Physiological Review* 2000; 80 (3): 1107-1213.
- [8] Stockler S, Holzbach U, Hanefeld F, Marquardt I, Helms G, Requart M, Hanicke W and Frahm J. Creatine deficiency in the brain: a new, treatable inborn error of metabolism. *Pediatr Res* 1994; 36: 409-413.
- [9] Bianchi MC, Tosetti M, Fornai M, Alessandri MG, Cipriani P, de Vito G and Canapicchi R. Reversible brain creatine deficiency in two sisters with normal blood creatine level. *Ann Neurol* 2000; 47: 511-513.
- [10] Caldeira Araujo H, Smit W, Verhoeven NM, Tomas H, Silva S, Vasconcelos R, Tavares de Almeida I, Jakobs C, Duran M. Urinary uric acid vs creatinine

Urinary uric acid to creatinine ratio in GAMT deficiency

- as a screening tool for GAMT deficiency. *J Inherit Metab Dis* 2002; 25 Suppl 1: 145.
- [11] Hunneman DH and Hanefeld F. GC-MS determination of guanidinoacetate in urine and plasma. *J Inherit Metab Dis* 1997; 20: 450-52.
- [12] Duran M, Dorland L, Meuleman EEE, Allers PJ and Berger R. Inherited defects of purine and pyrimidine metabolism: laboratory methods for diagnosis. *J Inherit Metab Dis* 1997; 20: 227-236.
- [13] Duran M. Miscellaneous analyses. In: Physician's Guide to the Laboratory Diagnosis of Metabolic Diseases, N. Blau, M. Duran, M.E. Blaskovics, K.M. Gibson eds., 2003, Springer-Verlag Heidelberg, pp 45-55.
- [14] Kaufman JM, Greene ML and Seegmiller JE. Urine uric acid to creatinine ratio-a screening test for inherited disorders of purine metabolism, *J Pediatr* 1968; 73 (4): 583-92.
- [15] Lawson N, Lang T, Broughton A, Prinsloo P, Turner C, Marenah C. Creatinine assays: time for action? *Ann Clin Biochem* 2002; 39: 599-602.
- [16] Schulze A, Ebinger F, Rating D, Mayatepek E. Improving treatment of guanidinoacetate methyltransferase deficiency: reduction of guanidinoacetate in body fluids by arginine restriction and ornithine supplementation. *Mol Genet Metab* 2001; 74: 599-602.

**GUANIDINOACETATE METHYLTRANSFERASE DEFICIENCY
IDENTIFIED IN MENTALLY RETARDED ADULTS.**

Helena Caldeira Araújo, Wilma Smit, Nanda M. Verhoeven, Gajja Salomons, Saturnino Silva, Rui Vasconcelos, Helena Tomás, Isabel Tavares de Almeida, Cornelis Jakobs and Marinus Duran.

Submitted for publication in *American Journal of Medical Genetics*.

ABSTRACT

Objectives

To describe the adult clinical and biochemical spectrum of guanidinoacetate methyltransferase (GAMT) deficiency, a recently discovered inborn error of metabolism. The majority of the previous reports dealt with paediatric patients, in contrast to the present paper.

Study design

A total of 180 institutionalised patients with a severe mental handicap were investigated for urine and plasma uric acid and creatinine. Patients with an increased urinary uric acid / creatinine ratio and / or decreased creatinine were subjected to the analysis of guanidinoacetate (GAA).

Results

Four patients (3 related and one from an unrelated family) were identified with GAMT-deficiency. A fifth patient had died before a biochemical diagnosis could be made. They all had shown a normal psychomotor development for the first year of life, after which they developed a profound mental retardation. Three out of four had convulsions and all four totally lacked the development of speech. Their GAMT activity in lymphoblasts was impaired and two novel mutations were identified: the 59 G>C and 506 G>A missense mutations. Urinary guanidinoacetate (GAA) was increased, but highly variable 347-1624 mmol/mol creat (Controls <150 mmol/mol creat). In plasma and CSF the GAA levels were fairly constant at 17.3-27.0 $\mu\text{mol/L}$ (Controls: 1.33-3.33) and 11.0-12.4 $\mu\text{mol/L}$ (Controls: 0.068-0.114), respectively.

Conclusions

GAMT deficiency in adults is associated with severe mental retardation and absence or limited speech development. Convulsions may be prominent. The non-specific nature of the clinical findings as well as the limited availability of GAA assays and / or in vivo magnetic resonance spectroscopy of the brain may cause that many more patients remain undiagnosed in institutions for the mentally handicapped.

INTRODUCTION

Creatine is utilised in the muscle and brain, where the pool of creatine-creatine phosphate, together with creatine kinase and ATP/ADP provides a high energy phosphate buffering system. This creatine-creatine phosphate system plays, therefore, an important role in the storage and transmission of phosphate-bound energy [Stöckler-Ipsiroglu et al., 1997; Wyss et al., 2002]. Creatine is synthesised from arginine in a two-step mechanism (Fig. 1). The transfer of the amidino group from arginine to glycine results in guanidinoacetic acid and ornithine. This represents the first step which occurs mainly in the kidney and is catalysed by arginine: glycine amidinotransferase (AGAT). Guanidinoacetic acid is then transported to the liver where it is methylated at the amidino group by S-adenosylmethionine, thereby forming creatine. This last step is catalysed by guanidinoacetate methyltransferase (GAMT) [Stöckler et al. 1994-1996; Von Figura et al., 2000; Wyss et al., 2000].

Creatine and creatine phosphate are non-enzymatically converted to creatinine (with a constant daily turnover of 1.7% of body creatine) which passively diffuses out of cells and is excreted by the kidneys in the urine [Von Figura et al., 2000; Wyss et al., 2002].

GAMT deficiency is an autosomal recessive disorder of creatine biosynthesis and was discovered by Stöckler et al. [1994]. It is characterized by decreased concentrations of creatine in the brain, cerebrospinal fluid, plasma and urine and by an accumulation of guanidinoacetate (GAA) in body fluids. The clinical phenotype is heterogeneous and not yet well defined but common manifestations are developmental delay or arrest during the first months of life, neurological deterioration, intractable epilepsy, extrapyramidal movement disorder, speech disability and muscular hypotonia and weakness [Wyss et al., 2002; Schulze et al., 1997; Stöckler-Ipsiroglu and Jakobs, 2002]. Some patients presented autistic-like and self-injurious behaviour [Ganesan et al., 1997; Von Figura et al., 2000; Van der Knaap et al., 2000].

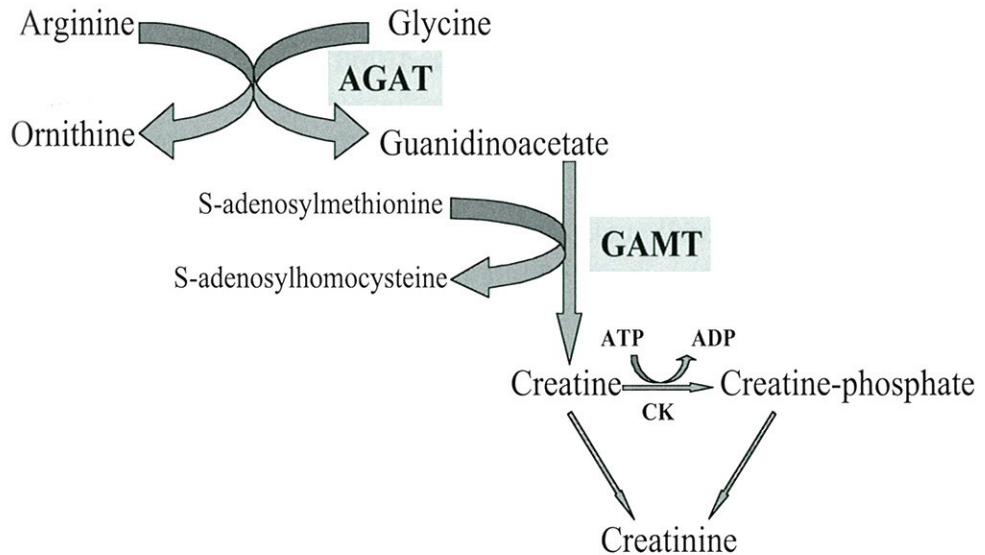

Figure 1 - Metabolic pathway of creatine

Diagnosis of GAMT deficiency is currently made by measuring GAA concentrations in plasma and urine [Hunneman et al., 1997; Struys et al., 1998; Bodamer et al., 2001]. Confirmation of the diagnosis is made by mutational analysis and enzyme assays [Stöckler et al., 1996; Ilas et al., 2000; Verhoeven et al., 2001; Item et al., 2002].

Oral supplementation with creatine improved clinical manifestations although none of the patients returned to normal. It slowly increased the total creatine concentration in the brain and normalised urinary creatinine excretion [Stöckler et al., 1996 and 1997]. However, even after several months of treatment, total creatine concentration in the brain remained significantly below the normal range and guanidinoacetic acid concentrations remained highly elevated in body fluids. In order to improve the clinical features, combination treatments have been tried, like creatine supplementation combined with arginine restriction [Schulze et al., 1998],

which failed to normalise GAA concentrations. However, a combination of creatine and ornithine supplementation and arginine restriction diminished GAA concentration in body fluids and reduced the epileptogenic activity suggesting that GAA is neurotoxic [Schulze et al. 2001].

Only 14 patients suffering from this disease have been published so far [Stöckler et al., 1994; Schulze et al., 1997; Ganesan et al., 1997; Van der Knaap et al., 2000; Leuzzi et al., 2000; Ensenauer et al., 2000; Stöckler-Ipsiroglu et al., 2002; Korall et al., 2002; Schulze et al., 2003]. In this paper we report the clinical outcome and laboratory findings of five (four proven and one presumed) patients with GAMT deficiency who were initially investigated based on a high urine uric acid / creatinine ratio [Caldeira et al., 2002]. Because the number of patients is still small and to our knowledge there is little information on long-term outcome of this disease we add information on these four patients.

Patient reports

Family 1: Patients 1 - 3 are the first three daughters out of four children from healthy consanguineous parents. They are now 26 and 29 years old, respectively, whereas their third daughter died at the age of 22 years (see figure 2). The fourth child is an unaffected male.

Patient 1 was born after a normal pregnancy with a birth weight of 3.250 Kg, she had an uneventful newborn period and showed a healthy development until the age of 12 months, started to walk and to express single words. She had an episode of febrile convulsions and, followed by the loss of acquired functions, started having seizures and had a progressive developmental regression ending up severely mentally handicapped. Patient 2 and 3 (twin sisters) started with convulsions at the age of 5 months and development retardation became evident. They walked at 2_ years of age with aid and they never acquired speech. All three sisters were institutionalised, at 17 and 14 years (the twins) of age respectively and one of the twin sisters died 8 years later, at the age of 22. The clinical course of these patients was progressive, the first presenting symptoms were mainly

severe mental retardation with an IQ<20, behavioural problems of moderate degree (i.e. aggressive and self injurious) which have progressed with age. They had a severe language delay with absent speech development; mild, drug responsive epilepsy with sporadic, tonic clonic and head drop seizures, not improving with age. The neurological deficits, which have been deteriorating with age, are of moderate degree with muscular hypertonia and rigidity. Vision and hearing are normal.

Family 2: Patient 4, a third cousin of patients 1–3 (see figure 2), was an 8-year-old boy. He was the first son of a healthy couple who also had a 3 year-old daughter with cerebral palsy and blindness. The boy showed to be a hypotonic baby, did not react nor smile and did not show any pre-speech behaviour nor any interest in communicating with the parents. He held his head at 5 months of age, sat with support at 8 months and walked at the age of 14 months. He was extensively investigated for underlying metabolic disorders with no conclusions. At 8 years of age he had a profound mental retardation, he was hyperactive with occasional aggressive behaviour, did not acquire speech but understood a few simple commands. Sometimes he had an autistic-like behaviour, his personal and social development were severely affected. The motor skills were the less compromised area of his development. He had a normal growth and his head circumference was on the 50th percentile. He had moderate neurological deficits with spasticity of the inferior limbs, ataxia and tremor. He also had bilateral Babinski and hyperreflexia. The EEG showed to be normal without peroxistic activity and the computerised axial tomography was normal. This patient, unlike the related patients, did not present with epilepsy. His vision and hearing were normal. Recently he has been hospitalised with frequent vomiting.

Family 3: This family is unrelated to the previous 2 families. Patient 5, the 19 year-old daughter of healthy non-consanguineous parents, was born after a normal pregnancy and labour with a weight of 3.450 kg. Her father has had a severely retarded son, from a previous marriage, who has died already. The mother has two adult sons from her first marriage, one with

Chapter 6

behavioural problems. This patient sat without support at 9 months, walked at 2 years of age and started receiving support from special education at 5 years of age when her development clearly showed to be severely compromised.

The delayed psychomotor development was noticed between 1 and 2 years of age. Her objective IQ was below 20. Epilepsy and neurological handicap progressed and deteriorated with age. She had no aggressive nor self-injurious behaviour. She suffered from sporadic, drug responsive, head drop seizures which deteriorated with age. EEG recordings showed multifocal spike wave changes of moderate degree. A severe language delay with the expression of few single words only, was observed. Moderate degree neurological deficits such as generalized hypertonia and rigidity have worsened with age. Normal vision and hearing functions were observed.

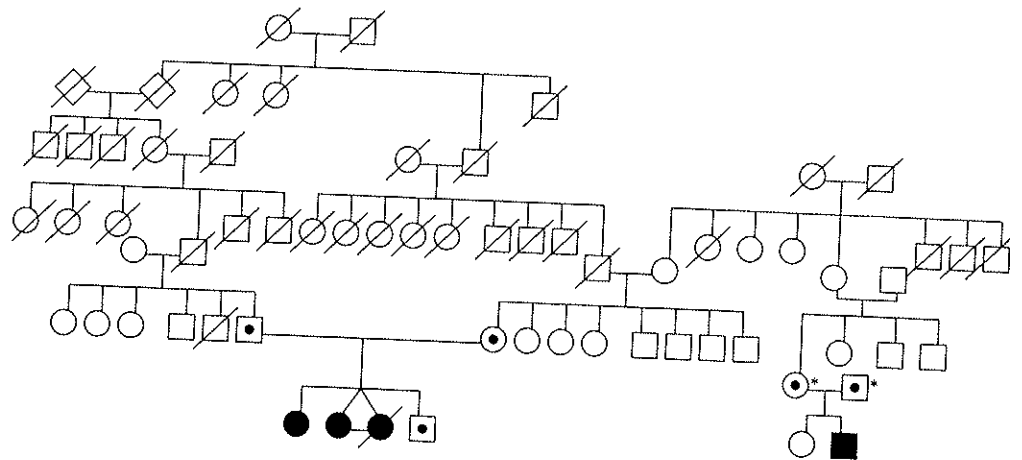

Figure 2 - Pedigree of the family of patients 1-4.

Symbols used: ● ■ homozygous; ⊙ ⊚ heterozygous, * presumably heterozygous (not confirmed); ◇ unknown sex; ♂/♀/◇ deceased

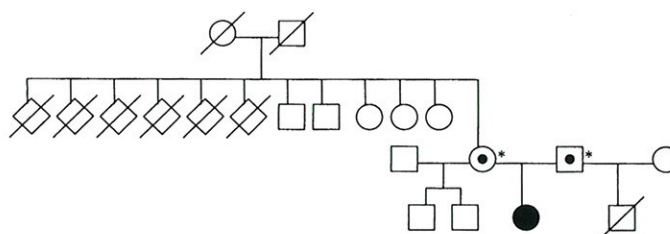

Figure 3 - Pedigree of the family of patient 5.

Symbols used: ● ■ homozygous; ○ □ heterozygous, * presumably heterozygous (not confirmed); ◇ unknown sex; ▧ ▨ ▩ deceased

MATERIALS AND METHODS

Samples

Overnight fasting blood samples were collected in lithium heparinate containing tubes and EDTA tubes. Early morning urines were collected in sterilized flasks.

Lithium heparinate blood samples were immediately centrifuged at 1600 g for 12 min and the initial plasma and urine analysis was processed within 2 hours. EDTA blood samples were kept at room temperature to allow EBV transformation of lymphoblasts.

Measurement of uric acid and creatinine

Creatinine and uric acid concentrations in plasma and urine were measured by a kinetic Jaffé method without deproteinisation and an enzymatic colorimetric test using uricase, respectively. All the reagents were supplied by Boehringer (Mannheim, Germany). These tests were performed on a

Hitachi 912 analyser (Boehringer Mannheim, Mannheim, Germany) according to the instructions of the manufacturer.

Guanidinoacetic acid analysis

Guanidinoacetic acid was determined in plasma and urine by stable isotope dilution assay using $^{13}\text{C}_2$ -GAA as internal standard. This method requires a derivatisation procedure before chromatographic analysis. Guanidinoacetic acid was first converted to N-bis-4,6-(Trifluoromethyl)pyrimidinyl-aminoacetic acid by reaction with hexafluoro-acetylacetone and then, by addition of (Methyl-TertiaryButyl) TrimethylSilylTrifluoroAcetamide (MTBSTFA) to this first reaction product, the tert-butyl-dimethylsilyl-N-bis-4,6-(trifluoromethyl)pyrimidinyl-acetate derivative was formed. The quantitative determination of GAA was then carried out by gas chromatography / mass spectrometry (GC/MS) with selected ion monitoring (SIM), using $^{13}\text{C}_2$ -guanidinoacetic acid as internal standard.

Measurement of Guanidinoacetate methyltransferase (GAMT) activity in lymphoblasts

Guanidinoacetate methyltransferase activity was determined in cultured lymphoblasts by incubating the cells with stable isotope labelled guanidinoacetate and labelled S-adenosylmethionine. Analysis of the formed labelled creatine was made by gas-chromatography / mass spectrometry [Verhoeven et al., 2001]. A detailed full description of this method will be submitted elsewhere.

Mutational analysis of the GAMT gene

Genomic DNA was isolated from blood of the patients and family relatives. The GAMT gene comprises 6 exons. These exons and the adjacent splice sites were amplified by the polymerase chain reaction (PCR) using published primers [Isbrandt et al., 1995]. Amplification was initiated after a 15 min denaturation and HotstarTaq (Qiagen) activation step at 95°C, followed by 35 cycles of denaturation, annealing and amplification (cycle: 45s at 94°C, 45s at 56°C and 1 min at 72°C). The PCR products were purified and analysed for proper size and quantity on a 1% agarose gel.

Subsequently the purified PCR products (Millipore vacufold multiscreen PCR plates) were directly sequenced using bigdye terminators and an ABI3100 sequencer. The obtained sequences were aligned using the blast tool of NCBI using the genomic GAMT sequence as reference: I20336210 (<http://www.ncbi.nlm.nih.gov/GenBank/>).

DNA analysis was performed by PCR amplification and sequence analysis of the amplification product.

RESULTS

Patients 1 and 2 were initially picked up by high urinary uric acid / creatinine ratios with frankly normal uric acid levels and slightly low plasma creatinine concentrations, as compared to controls. These results raised the suspicion of too low urinary creatine concentrations, possibly due to a creatine biosynthesis defect. Assessment of guanidinoacetic acid showed highly elevated excretions in both patients. This metabolite was also present in the plasma and CSF at abnormally high levels as can be seen in Table I.

GAMT deficiency was subsequently confirmed enzymatically and by mutational analysis (Table II) in patients 1 and 2. The activity of guanidinoacetate methyltransferase was undetectable in lymphoblasts. Mutation analysis showed a novel homozygous missense mutation in the GAMT gene. This mutation, a G to C transversion (c.59G>C), is located in exon 1 and results in the substitution of tryptophan by serine at position 20 (W20S).

We decided to investigate other members of the family and found a slight increase of plasma guanidinoacetate in the father and brother but not in the mother. Their urinary guanidinoacetate excretion was normal (Table III). Mutation analysis of the parents showed both to be carriers of the W20S mutation. The brother also showed to be a carrier of this mutation. The diagnosis of the twin girl (patient no 3) could not be confirmed, because no material had been stored.

Chapter 6

Table I. Laboratory investigation of body fluids from the four patients compared to control values.

Metabolite		Patient 1	Patient 2	Patient 3	Patient 4	Controls
Plasma	Uric acid (mmol/L)	0.17	0.22	0.18	0.27	0.14-0.41
	Creatinine (mmol/L)	0.033	0.037	0.018	0.034	0.035-0.122
	Guanidinoacetic acid (μ mol/L)	17.3	25.8	19.7	27.0	1.3-3.3
Urine	Uric acid (mmol/L)	1.03	0.75	0.33	2.77	2.18-5.43
	Creatinine (mmol/L)	0.68	0.92	0.43	3.15	2.48-22.9
	Ratio (mol/mol)	1.50	0.82	0.77	0.88	< 0.92(M)/0.96(F)
	Guanidinoacetic acid (mmol/mol creat.)	614	742	347	1624	< 150
CSF	Guanidinoacetic acid (μ mol/L)	12.4	11.3	-	11.0	0.068-0.114

Patient 4 was studied for several reasons. The familial relation with patients 1-3, some common symptoms and, finally, a relatively high urinary uric acid/creatinine ratio as well as a low plasma creatinine. The high guanidinoacetate excretion and the strongly increased plasma concentration constituted clear evidences of GAMT deficiency (Table I). The activity of guanidinoacetate methyltransferase was not detectable in lymphoblasts and mutational analysis of the GAMT gene showed this patient to be homozygous for the W20S; 59G>C mutation (Table II), the same mutation as that of his relatives, as was expected.

Based upon the high urinary uric acid/creatinine ratio and low plasma creatinine we investigated patient 5. Also in this case, an accumulation of

guanidinoacetic acid in body fluids was observed (Table I). Studies of her enzyme activity in lymphoblasts confirmed a deficiency in GAMT, and DNA sequence analysis showed a new missense mutation in the GAMT gene. This mutation, a G to A transition (c.506G>A), is located in exon 5 and results in the substitution of cysteine by tyrosine at position 169 (C169Y) (Table II).

Table II. Results of mutation analysis and GAMT activity of the patients.

	Mutation		GAMT activity (pmol/h mg protein)
	Allele 1	Allele 2	
P1	c.59G>C	c.59G>C	< 5
P2	c.59G>C	c.59G>C	< 5
P3	c.59G>C	c.59G>C	< 5
P4	c.506G>A	c.506G>A	< 5
Controls			63-271

Table III. Laboratory investigation of the family of patients 1 and 2.

	Metabolite	Mother	Father	Brother	Controls
Plasma	Guanidinoacetic acid ($\mu\text{mol/L}$)	2.6	7.1	4.8	1.3-3.3
Urine	Guanidinoacetic acid (mmol/mol creat.)	50.0	38.8	20.2	< 150

DISCUSSION

The importance of the availability of creatine for normal brain function has long been recognised, but its full impact has only been revealed by the discovery of the creatine deficiency syndromes. These include the X-linked creatine transporter defect (Salomons et al., 2001), the arginine:glycine amidinotransferase deficiency (Item et al., 2001), and guanidinoacetic acid methyltransferase deficiency (Stöckler et al., 1996). Although the latter condition was studied most extensively, only fourteen patients have been reported so far, making the natural history of the disorder relatively unclear. Our report on five patients from a relatively small community (250 000) demonstrates the clinical heterogeneity of GAMT-deficiency, even in patients with identical mutations of the gene. This was shown most clearly in patients 1 and 2 on the one hand and their distant cousin (patient 4) on the other hand. The diagnosis for one of the twin sisters could not be confirmed, due to the absence of stored material. All showed a more or less normal early motor development: they were able to sit, stand, and walk at a given moment. From the second year of life they showed a rapid mental regression. Remarkably, this was initiated in the three sisters by their convulsions whereas the boy never had any seizures. This observation

stresses the fact that GAMT-deficiency is not necessarily associated with seizures, thereby making the clinical preselection for screening more broad. In contrast the boy clearly had behavioural disturbances which were not observed in the female cousins.

The non-related patient 5 – she had an entirely different mutation – displayed a similar course as that of the two sisters, her seizures being slightly less severe. Also in this girl the first year of life passed relatively uneventful.

It is tempting to relate the severity of the clinical symptoms to the extent of the biochemical abnormalities. In this respect both the effect of creatine deficiency and the possible toxic action of guanidinoacetate have to be taken into account (Schulze et al. 2001). Our three patients (no 1, 2 and 5) in whom CSF guanidinoacetate could be measured, had remarkably similar

levels (Table 1). Their clinical evolution was comparable: all three developed convulsions, which were somewhat less severe in patient 5, however. Also the plasma GAA levels were of the same order of magnitude in all patients, roughly tenfold increased above the control levels. In contrast, the urine excretion of GAA differed markedly between the four patients; by far the highest level was found in patient 5. Urinary levels may reflect the daily production rate of GAA, and inversely that of creatine (phosphate). It struck us that the least severely affected patient (no 4, Table 1) had the lowest urine GAA level, only twice the currently accepted upper normal level. We cannot exclude an age dependency of the guanidinoacetate excretion levels, although no examples have been given in the literature. The arginine to creatinine pathway is under the control of the ornithine levels, which influence the AGAT-activity. Young children have a relatively higher daily protein intake and it may be assumed that their peak ornithine levels are slightly higher. Accordingly their guanidinoacetate may be expected to be lower, of course with the same degree of creatine deficiency. In its extreme, these considerations may support the idea of guanidinoacetate being toxic, as also put forward by Schulze et al., 2001. The relatively fair development in the first year of life – a period with high protein (ornithine) intake – could thus be explained. Both male heterozygous subjects who could be studied (Table III) had mildly elevated plasma GAA levels, in the same range as those observed in hyperargininemia patients (data not shown). As the heterozygotes had an entirely normal neurological function, we question the deleterious effect of GAA at this moderate level.

Although creatine phosphate is absolutely essential for normal muscle function, no muscular symptoms were observed. This is in agreement with the other patients reported in the literature (Schulze et al., 2003).

GAMT takes care of the transfer of a methyl group of S-adenosylmethionine to guanidinoacetate, thereby forming S-adenosylhomocysteine and eventually homocysteine. It is conceivable that GAMT-deficiency will result in lowered homocysteine levels. This was clearly demonstrated in patients 1 and 2. The levels of CSF S-adenosylmethionine in patient 1 and 2 were either in the high normal range or moderately increased. In contrast

Chapter 6

their S-adenosylhomocysteine levels were not decreased (data not shown). The significance of these findings is not entirely clear, moreover because we do not know which regulatory systems play a role in maintaining optimum levels of these substances. In conclusion we have demonstrated that patients with GAMT-deficiency may well survive into adult age. They function at a quite low intellectual level following a clear downhill course after their first year of life. It is to be expected that more – treatable – patients will be found in institutions for the mentally handicapped. As shown by Schulze et al. (2003), treatment can be started with success at any age.

ACKNOWLEDGMENT

The authors wish to thank Mrs. S.M. Gersen-van Zadel for her invaluable help in preparing the manuscript.

REFERENCES

Bodamer OA, Shannon MB, Gregg AR, Stöckler-Ipsiroglu S, O'Brien WE. 2001. Analysis of guanidinoacetate and creatine by isotope dilution electrospray tandem mass spectrometry. *Clin Chim Acta* 308: 173-178.

Caldeira Araújo H, Smit W, Verhoeven NM, Tomas H, Silva S, Vasconcelos R, Tavares de Almeida I, Jakobs C, Duran M. 2002. Urinary uric acid vs creatinine as a screening tool for GAMT deficiency. *J Inherit Metab Dis* 25 (Suppl 1): 145.

Caldeira Araújo H, Tomás H, Silva S, Vasconcelos R, Smit W, Tavares de Almeida I, Duran M. 2003. Urinary uric acid / creatinine ratio as a screening tool for creatine biosynthesis defects. (for publication)

Ensenauer R, Thiel T, Schwab KO, Lehnert W. 2000. Presence of muscle creatine in a patient with guanidinoacetate methyltransferase (GAMT) deficiency. *J Inherit Metab Dis* 23 (Suppl.1): 212.

Ganesan V, Johnson A, Connelly A, Eckhardt S, Surtees RAH. 1997. Guanidinoacetate methyltransferase deficiency: new clinical features. *Pediatr Neurol* 17: 155-157.

Hunneman DH, Hanefeld F. 1997. GC-MS determination of guanidinoacetate in urine and plasma. *J Inherit Metab Dis* 20: 450-452.

Ilas J, Muhl A, Stockler-Ipsiroglu S. 2000. Guanidinoacetate methyltransferase (GAMT) deficiency: non-invasive enzymatic diagnosis of a newly recognized inborn error of metabolism. *Clin Chim Acta* 290: 179-188.

Isbrandt D, Von Figura K. 1995. Cloning and sequence analysis of human guanidinoacetate N-methyltransferase cDNA. *Biochim Biophys Acta* 1264: 265-267.

Item CB, Stromberger C, Mühl A, Edlinger C, Bodamer OA, Schulze A, Surtees R, Leuzzi V, Salomons GS, Jakobs C, Stockler-Ipsiroglu S. 2002. Denaturing gradient gel electrophoresis for the molecular characterization of six patients with guanidinoacetate methyltransferase deficiency. *Clin Chem* 48: 767-769.

Korall H, Wallner S, Löffler M. 2002. High throughput screening for guanidinoacetate methyltransferase (GAMT) deficiency by tandem mass spectrometry in urine. *J Inherit Metab Dis* 25 (Suppl. 1): 144.

Leuzzi V, Bianchi MC, Tosetti M, Carducci C, Cerquiglini A, Cioni G, Antonozzi I. 2000. Brain creatine depletion: guanidinoacetate methyltransferase deficiency (improving with creatine supplementation). *Neurology* 55: 1407-1409.

Schulze A, Hess T, Wevers R, Mayatepek E, Bachert P, Maresceau B. 1997. Creatine deficiency syndrome caused by guanidinoacetate methyltransferase deficiency: diagnostic tools for a new inborn error of metabolism. *J Pediatr* 131: 626-631.

Chapter 6

Schulze A, Mayatepek E, Bachert P, Maresceau B, De Deyn PP, Rating D. 1998. Therapeutic trial of arginine restriction in creatine deficiency syndrome. *Eur J Pediatr* 157: 606-607.

Schulze A, Ebinger F, Rating D, Mayatepek E. 2001. Improving treatment of guanidinoacetate methyltransferase deficiency: reduction of guanidinoacetic acid in body fluids by arginine restriction and ornithine supplementation. *Mol Genet Metab* 74: 413-419.

Schulze A, Backert P, Schlemmer H, Harting I, Polster T, Salomons GS, Verhoeven NM, Jakobs C, Fowler B, Hoffmann GF, Mayatepek E. 2003. Lack of creatine in muscle and brain in an adult with GAMT-deficiency. *Annals Neurol* 53: 248-251.

Stöckler S, Holzbach U, Hanefeld F, Marquardt I, Helms G, Requart M, Hänicke W, Frahm J. 1994. Creatine deficiency in the brain: A new, treatable inborn error of metabolism. *Pediatr Res* 36: 409-413.

Stöckler S, Hanefeld F, Frahm J. 1996. Creatine replacement therapy in guanidinoacetate methyltransferase deficiency, a novel inborn error of metabolism. *Lancet* 348: 789-790.

Stöckler S, Isbrandt D, Hanefeld F, Schmidt B, von Figura K. 1996. Guanidinoacetate methyltransferase deficiency: the first inborn error of creatine metabolism in man. *Am J Hum Genet* 58: 914-922.

Stöckler S, Marescau B, De Deyn PP, Trijbels JM, Hanefeld F. 1997. Guanidino compounds in guanidinoacetate methyltransferase deficiency, a new inborn error of creatine synthesis. *Metabolism* 46: 1189-1193.

Stöckler-Ipsiroglu S. 1997. Creatine deficiency syndromes: A new perspective on metabolic disorders and a diagnostic challenge. *J Pediatr* 131: 510-511.

Stöckler-Ipsiroglu S, Jakobs C. 2002. Creatine Deficiency Syndromes. 34th European Metabolic Group Meeting, Zurich.

Struys EA, Jansen EEW, Ten Brink HJ, Verhoeven NM, Van der Knaap MS, Jakobs C. 1998. An accurate stable isotope dilution gas chromatographic-mass spectrometric approach to the diagnosis of guanidinoacetate methyltransferase deficiency. *J Pharm Biomed Anal* 18: 659-665.

Van der Knaap MS, Verhoeven NM, Maaswinkel-Mooij P, Pouwels PJ, Onkenhout W, Peeters EA, Stöckler-Ipsiroglu S, Jakobs C. 2000. Mental retardation and behavioural problems as presenting signs of a creatine synthesis defect. *Ann Neurol* 47: 540-543.

Verhoeven NM, Schor DSM, Roos B, Struys EA, Van der Knaap MS, Salomons GS, Jakobs C. 2001. Stable isotope dilution enzyme assays for the detection of inborn errors of creatine biosynthesis. *J Inherit Metab Dis* 24 (Suppl. 1): 118.

Von Figura K, Hanefeld F, Isbrandt D, Stöckler-Ipsiroglu S. 2000. Guanidinoacetate methyltransferase deficiency. In: Scriver CR, Beaudet AL, Valle D, Sly WS, editors. *The Metabolic and Molecular Bases of Inherited Disease*. New York: McGraw Hill, p 1897-1908.

Wyss M, Kaddurah-Daouk R. 2000. Creatine and creatinine metabolism. *Physiol Rev* 80: 1107-1213.

Wyss M, Schulze A. 2002. Health implications of creatine: can oral creatine supplementation protect against neurological and atherosclerotic disease? *Neuroscience* 112: 243-260.

**GUANIDINOACETIC ACID IS DECREASED IN
HYPERORNITHINEMIA.**

**Helena Caldeira Araújo, Wilma Smit, Bwee-Tien Poll-The, H. D.
Bakker and Marinus Duran.**

Submitted for publication in *Journal of Inherited Metabolic Diseases*.

ABSTRACT

Ornithine, which is formed from arginine by the arginase reaction, is a known inhibitor of the enzyme arginine:glycine amidinotransferase, the first reaction in the creatine biosynthetic pathway. It has been known for some time that patients with hyperornithinemia due to ornithine aminotransferase (OAT) deficiency may develop a creatine deficiency. We now present evidence of a shortage of guanidinoacetate, the intermediate in the creatine biosynthetic pathway, in four patients with hyperornithinemia. Treatment of hyperornithinemia patients with guanidinoacetate may be beneficial.

INTRODUCTION

Isolated hyperornithinemia without hyperammonemia results from a deficiency of ornithine- δ -aminotransferase (OAT). Affected patients have gyrate atrophy of the choroid and retina (Simell and Takki, 1973). The ophthalmologic abnormalities develop slowly with age and are accompanied by selective atrophy of type II muscle fibers (Sipilä et al., 1979). It has recently been shown that approximately half of the patients will develop neuropathy (Peltola et al., 2002).

The pathogenesis of hyperornithinemia remains obscure. Sipilä (1980) gave evidence of the inhibition of arginine:glycine amidinotransferase (AGAT), the first enzyme of creatine biosynthesis, by ornithine. Subsequently it was shown that hyperornithinemia patients have reduced levels of creatine throughout the organism, including brain (Näntö-Salonen et al., 1999). Similar deficiencies of creatine were observed in the recently discovered inherited defects of creatine biosynthesis such as guanidinoacetate methyltransferase (GAMT) deficiency (Stöckler et al., 1996), and arginine:glycine amidinotransferase (AGAT) deficiency (Item et al., 2001). Both the increased levels of ornithine and the decreased availability of creatine (and creatine phosphate) may cause neuronal damage (Peltola et al., 2002). The role of guanidinoacetate (GAA), the immediate precursor of creatine, has not been investigated in hyperornithinemia thus far, although

this substance may well have an important function (Schulze et al., 2003). We here describe guanidinoacetate levels in four hyperornithinemia patients and speculate on alternative therapeutic approaches.

PATIENTS AND METHODS

Four patients with hyperornithinemia due to OAT deficiency were studied, one male and three females. Their ages ranged from 18-40 years. All had been diagnosed several years previously with gyrate atrophy of the choroid and retina. Treatment consisted of a low protein diet.

Patient 1 (m) was an adopted child, originating from Sri Lanka. At 8 months strabismus was observed and operative correction was performed at 3 years, after which he needed glasses. He was referred by an ophthalmologist at age 14 years because of gyrate atrophy. There was a mild delay in cognitive and motor development. He was treated with a protein-restricted diet (50 g/day) from the age of 15 onwards resulting in stabilisation of his visual function. MRI and MRS of the brain at 17 years were normal.

Patient 2 (f) was referred by an ophthalmologist at the age of 30 years because of gyrate atrophy. No other physical abnormalities were present. She complained of generalized non-specific discomfort. Although a protein restricted diet has not induced a reduction of plasma ornithine levels, her visual deficit showed no further deterioration.

Patient 3 (f) had been diagnosed at the age of 5 when she was investigated because of seizures. A progressive visual handicap had been observed from the age of 18 months. An EMG at the age of 12 was normal (Bakker et al., 1991). Treatment with severe dietary arginine restriction (13 mg/kg/day) resulted in normalisation of plasma ornithine (37 $\mu\text{mol/L}$), but was abandoned later.

Patient 4 (f) was referred at the age of 10 because of gyrate atrophy. She had a single convulsion at the age of 3. An EMG at 10 years showed minimal irregularities; a muscle biopsy at 15 showed no abnormalities. Various treatment strategies have been attempted, including extra lysine and protein

restriction. The ophthalmological abnormalities have stabilised and she has given birth to a healthy daughter.

Plasma and urine amino acids were measured using a Jeol Aminotac amino acid analyser. Guanidinoacetate was analysed by stable isotope dilution gas chromatography / mass spectrometry of the tert-butyl-dimethylsilylated reaction product of GAA and hexafluoroacetylacetone using $^{13}\text{C}_2$ -GAA as internal standard, mainly following the conditions of Hunneman and Hanefeld (1997).

RESULTS AND DISCUSSION

Plasma and urine samples were collected during routine outpatient visits. The plasma ornithine levels varied from 451 to 792 (controls 27-98) in the four patients (Fig. 1). The latter value can hardly be the result of a low protein diet. These values stress the virtual inability of lowering plasma ornithine concentrations to a near normal level in adult OAT-deficient patients when not using amino acid mixtures replacing the natural protein. Urine and plasma GAA levels were measured in samples which had been stored at -20°C for up to 4 years.

Table 1 shows the values of GAA in the patients. Reference values were calculated from a hospital based population in whom neither inborn errors nor muscle disease could be established. All GAA levels were below the lower limit of the reference range, both in plasma and urine. When calculating the urine excretion values on a creatinine basis, it was striking to notice the low urine creatinine values of 1.4-2 mmol/L, reflecting the overall creatine deficiency of these patients. No correlation was found between the plasma ornithine and GAA concentrations (Fig. 1), although we did not have the opportunity to study plasma samples with ornithine concentrations below 400 $\mu\text{mol/L}$.

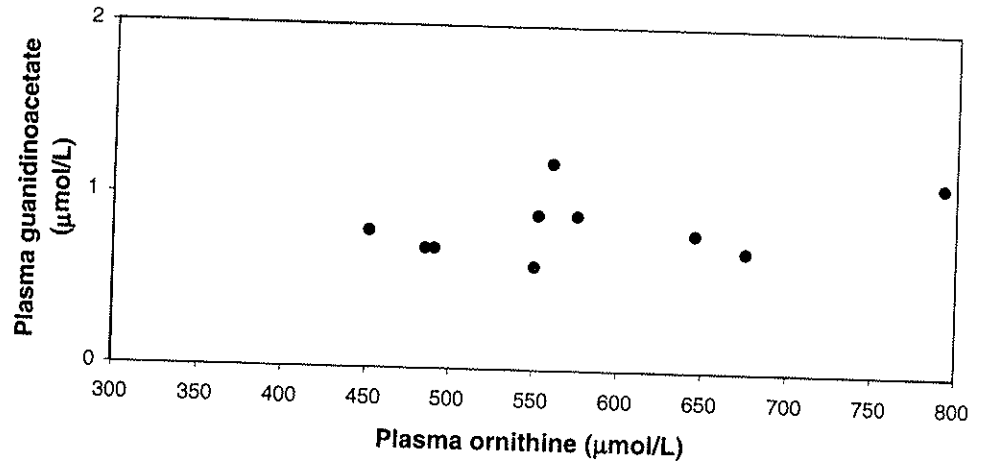

Fig 1 - Relationship between the plasma levels of ornithine and guanidinoacetate in adult patients with ornithine aminotransferase deficiency. Control GAA levels are in excess of 1.3 µmol/L, control ornithine levels are below 98 µmol/L.

Table 1. Guanidinoacetate levels in patients with hyperornithinemia due to OAT deficiency.

Patient	Plasma Gua (µmol/L)	Urine Gua (mmol/mol creat.)
1. (m)	1.1	n.a.
2. (f)	0.7 – 0.9	n.a.
3. (f)	0.7 – 1.2	3.3 – 4.5
4. (f)	0.6 – 0.8	3.0 – 11.9
Controls	1.3 – 3.3	15 – 150

n.a. – not analysed

A lowered level of guanidinoacetic acid is of potential significance. This substance is one of the most important methyl acceptors and may, thus, influence the level of S-adenosylmethionine, its main methyl donor. Low GAA levels have previously been reported in AGAT-deficiency (Item et al., 2001), but no direct evidence of its detrimental effect was supplied. On the other hand, increased GAA should be avoided at any time. This was clearly demonstrated by Schulze et al. (2003) who showed a GAMT-deficient patient to benefit from both creatine supplementation and reduction of the GAA level. We speculate that the GAA-level has an optimum window, coinciding with the normal reference range. Apart from the original ornithine-lowering treatment of OAT-deficiency, the oral supplementation of creatine has been advocated many years ago (Sipilä et al., 1981). In spite of the replenishment of creatine, many patients continued to have visual and neurological problems. The rate of progression of symptoms appeared to be slower, however. In this respect it is reassuring to see that OAT-deficient patients remained free from neuropathy when treated with a combination of guanidinoacetate and methionine instead of the more widely used creatine (Peltola et al., 2002). GAA has a ready access to nerve cells whereas creatine itself has only a limited transport into these cells (Dechent et al., 1999; Holtzman et al., 1997).

In our opinion treatment of hyperornithinemia due to OAT-deficiency can best be achieved by lowering the plasma ornithine levels combined with supplementation of guanidinoacetate and possibly methionine. This will not only take care of an adequate creatine supply, but will also result in nicely balanced methylation reactions, which are essential for the human organism.

REFERENCES

- Bakker HD, Abeling NGGM, van Schooneveld MJ, Wanders RJA, van Gennip AH (1991) A far advanced case of gyrate atrophy in a 12-year-old girl. *J Inherit Metab Dis* 14:379-381.

Chapter 7

Dechent P, Pouwels PJW, Wilken B, Hanefeld F (1999) Increase of total creatine in human brain after oral supplementation of creatine-monohydrate. *Am J Physiol* **277**:P6989-P704.

Holtzman D, Meyers R, O'Gorman E, et al (1997) In vivo brain phosphocreatine and ATP regulation in mice fed a creatine analog. *Am J Physiol* **272**:C1567-C1577.

Hunneman DH, Hanefeld F (1997) GC-MS determination of guanidinoacetate in urine and plasma. *J Inherit Metab Dis* **20**:450-452.

Item CB, Stöckler-Ipsiroglu S, Stromberger C, et al (2001) Arginine:glycine amidinotransferase deficiency: the third inborn error of creatine metabolism in humans. *Am J Hum Genet* **69**:1127-1133.

Nanto-Salonen K, Komu M, Lundbom N, et al (1999) Reduced brain creatine in gyrate atrophy of the choroid and retina with hyperornithinemia. *Neurology* **53**:303-307.

Peltola KE, Jaaskelainen S, Heinonen OJ, et al (2002) Peripheral nervous system in gyrate atrophy of the choroid and retina with hyperornithinemia. *Neurology* **59**:735-740.

Schulze A, Bachert P, Schlemmer H, et al (2003) Lack of creatine in muscle and brain in an adult with GAMT deficiency. *Ann Neurol* **53**:248-251.

Simell O, Takki K (1973) Raised plasma-ornithine and gyrate atrophy of the choroid and retina. *Lancet* **1**:1031-1033.

Sipilä I, Simell O, Rapola J, Sainio K, Tuuteri L (1979) Gyrate atrophy of the choroids and retina with hyperornithinemia: tubular aggregates and type 2 fiber atrophy in muscle. *Neurology* **29**:996-1005.

Sipilä I (1980) Inhibition of arginine-glycine amidinotransferase by ornithine. A possible mechanism for the muscular and chorioretinal atrophies in gyrate atrophy

GAA is decreased in hyperornithinemia

of the choroids and retina with hyperornithinemia. *Biochim Biophys Acta* **613**:79-84.

Stöckler S, Isbrandt D, Hanefeld F, Schmidt B, von Figura K (1996) Guanidinoacetate methyltransferase deficiency: the first inborn error of creatine metabolism in man. *Am J Hum Genet* **58**:914-922.

PART IV

CONCLUSIONS

CHAPTER

8

GENERAL DISCUSSION AND FUTURE PROSPECTS

1. GENERAL DISCUSSION

The study of interrelations between different metabolic pathways and their regulation mechanisms has revealed to be of major importance in the prospect of narrowing diagnostic schemes of inherited metabolic diseases aiming at their better recognition and treatment.

The purine and one-carbon metabolism are intimately associated through folates as co-enzymes in methyl-group transfer reactions which participate in the biosynthesis of the purine ring. Moreover, there is a relationship between both metabolic pathways via the remethylation pathway of homocysteine. Methionine formed is initially activated to SAM through ATP. SAM, the most important methyl donor in humans, donates its methyl group to a methyl acceptor generating SAH, which is subsequently hydrolysed to homocysteine and adenosine, the latter going back to the purine pool to be salvaged and inter-converted into other nucleosides, or broken down to uric acid.

Thus, the finding of an abnormality of one metabolic pathway in a patient will inevitably lead to additional laboratory investigations in order to probe the related pathways.

On the other hand, non-specific symptoms and clinical signs of most inborn errors of metabolism allied to the lack of specialised laboratories in most communities and high cost of new, more effective analytical equipment, which is still not affordable to most laboratories, emphasize the need for restriction of diagnostic programmes by means of selective screening.

Uric acid and creatinine are straightforward, routine clinical chemistry parameters, which correlate well with a series of disorders. However, a correct diagnosis commonly requires a combination of plasma and urine values. Uric acid can be used as a diagnostic marker of several inborn errors of metabolism and generally hyperuricosuria with hypouricaemia reflects renal tubular disorders. Diminished production of uric acid may be the result of several enzyme deficiencies such as XDH or PNP; secondary hyperuricosuria and hyperuricaemia may be observed in GSD I, MCAD or hereditary fructose intolerance. Besides, the urinary uric acid to creatinine ratio has long shown its value as a screening test for a number of disorders

of purine metabolism. The 24-hour urine sample, the screening fluid of choice is most of the times difficult to obtain, especially in children. This gives way to the collection of random urines where most metabolites are expressed in relation to the urine creatinine concentration, which is a quite invariable parameter [1].

However, the age, sex and diet-dependency of plasma and urine uric acid requires population studies, to establish reference values for each community, when searching for a correct diagnosis. Children have low plasma urate levels as a consequence of a better renal clearance and at puberty there is a marked fall in clearance rate. As a result, the plasma level rises, more apparently in males than in females. On the other hand, purine enriched diets elevate both plasma and urine urate levels [2].

Plasma and urine creatinine are good indicators of creatine stores in the body and they depend essentially on the muscle mass of healthy individuals. However, as values are method-dependent, control ranges are also a chief requirement.

Since ascertainment of uric acid and creatinine reference ranges is mandatory for every population, it was the purpose of our studies to investigate a large number of healthy schoolchildren and adolescents (approximately 350) before starting a screening programme of patients. We have concluded that mean plasma urate levels increased with age in both gender and that urate clearance did not decrease significantly with age as would be expected. Plasma and urine creatinine increased with age but more significantly in males reflecting the more pronounced increase in the muscle mass. This study also enabled us to select out some individuals, considered at risk for their high or low uric acid levels, for screening of purine and pyrimidine abnormalities, which became negative.

In addition, 170 undiagnosed mentally retarded patients, who could carry any underlying metabolic disorder, were screened. This investigation, besides uric acid and creatinine, also included purine and pyrimidine analysis by a reversed-phase HPLC method with diode-array detection. Drug and dietary interference in urines was overtaken by development of a solid-phase extraction purification step, which improved the separation and

permitted concentration of these metabolites, in spite of not being efficient enough to remove all interferents.

No abnormal patterns of purines and pyrimidines were found in any of these patients. Furthermore, it was concluded that the enhanced urinary uric acid to creatinine ratios, found in some of the studied patients were not associated with purine metabolism abnormalities. In agreement were the normal levels of uric acid in plasma.

Exclusion of purine metabolism abnormalities led us to hypothesize the existence of creatine biosynthesis defects in patients with high urinary uric acid to creatinine ratios. The subsequent step would then be evaluation of guanidinoacetic acid in urines. As a matter of fact, a prominent excretion of GAA indicated for GAMT deficiency in four of these patients. Plasma and CSF levels of GAA were in accordance with those results and the disease was further confirmed by enzyme studies and mutation analysis.

Thus, our studies have shown that the increased urinary uric acid to creatinine ratio may also be a useful alerting parameter for the presence of creatine biosynthesis defects. Accordingly, it can be used as a screening test for these defects in addition to the above-mentioned purine defects, although we have concluded that an even better approach is to plot the ratio against the urine creatinine. As a matter of fact, we have also verified that plasma and urine creatinine may be informative but not all GAMT-deficient patients have decreased values, especially if the Jaffé method is used, as already reported by Verhoeven et al. [3].

The clinical heterogeneity of the disease was demonstrated. Even for patients with the same mutation, the clinical phenotype was different. The plasma GAA levels of all patients were of the same order of magnitude but in the urine they differed deeply showing the lowest values in the youngest patient. These findings suggest that urinary levels may reflect the daily production of GAA. Furthermore, a possible age-dependency can be speculated caused by ornithine inhibition of AGAT activity due to a relative higher protein intake in children. Impairment of homocysteine metabolism and intermediates, in particular SAM and SAH, was suggested by the absence of GAMT enzyme. Actually, low plasma homocysteine levels were observed in two GAMT patients. However, SAM and SAH were both in the

high normal range or even slightly increased in the cerebrospinal fluid of these patients, which does not account for low plasma homocysteine as expected. In addition, normal levels of neurotransmitters indicated no disturbance in SAM function.

The low levels of GAA observed in patients suffering from gyrate atrophy of the choroid and retina with hyperornithinaemia indicated for an inhibitory effect of ornithine on AGAT activity. It may prove that GAA is an essential constituent of the human organism. Both increased and decreased levels may have a detrimental effect. This, in turn, may have therapeutic consequences for various conditions such as hyperornithinaemia and ornithine carbamoyl transferase deficiency.

Elucidation of the biochemical changes in GAMT deficiency will certainly contribute to a better understanding of the pathophysiological role of creatine and GAA and of the implications in one-carbon metabolism intermediates.

2. FUTURE PROSPECTS

The results presented here raise new queries and demand further studies in order to extend our knowledge on the role of the metabolites involved and on new approaches to therapy.

Our studies in chapter 3 have led to the conclusion that uric acid to creatinine ratio is a good indicator for GAMT deficiency. However, only some of the patients with high ratios were GAMT deficient, others were not. Since no abnormalities of purine metabolism were detected, the underlying cause is questioned.

Facing the high ratios in GAMT patients, the low creatinine concentration would be the most logical explanation. In spite of this, one of the patients presented a quite normal urine creatinine. A far interrelation exists between purine and creatine pathways. As such, GAMT deficiency may have reflexes in purine metabolism, especially adenosine. Further studies on intermediates SAM and SAH will possibly respond to this question. Further investigations are needed to elucidate possible implications.

In our study two new GAMT mutations were identified. This fact supports the belief that the disease has been underdiagnosed. The fact that two novel GAMT mutations were found in Madeira population, both in homozygous form, renders additional population genetic investigations on this island as very promising. A wider screening of mentally retarded patients involving other institutions would possibly increase the number of patients opening the possibility of extending knowledge on the clinical symptoms, biochemical patterns and treatment outcome.

Studies undertaken over the last years have tried to clarify the role of the creatine/phosphocreatine system in cellular energy metabolism. Attempts at treating GAMT deficient patients with creatine supplements showed to increase Cr/PCr in the brain but not to normal levels. This slow increase in brain creatine may reflect limited permeability of the blood-brain barrier. On the other hand, recent studies have shown that all brain cells are capable of performing creatine biosynthesis [4]. In spite of being essential to muscle function, no abnormalities of muscle have been described in GAMT patients. Furthermore, oral creatine supplementation decreased GAA levels, but these still remained highly elevated, which may explain the persistence of GAA neurotoxic effects, especially epilepsy [5]. Besides, it is not known whether these toxic effects are reversible or not. Discovery of guanidinoacetic methyltransferase may yield model systems capable of showing the crucial role of substances like creatine and guanidinoacetic acid.

No patient on creatine supplementation has returned to a normal developmental level and all lack active speech. The impact of dietary arginine restriction with creatine and ornithine supplementation tried by Schulze in one patient and which had a positive effect on GAA reduction is still not completely elucidated [6]. New treatment strategies that lead to a decrease of GAA in combination with creatine supplementation would certainly transform the outcome of these patients into a more favourable one.

The investigation of possible implications of GAMT deficiency in the overall one-carbon metabolism through its involvement in homocysteine metabolism and its intermediates was one of the initiated studies. Why were

the plasma homocysteine levels low in two patients? Since SAM and SAH were only investigated in CSF, assessment of the plasma would also be important to ascertain this point. Extension of these studies to a greater number of patients will possibly allow a better understanding of these processes, which are the regulatory mechanisms and the implications on methylation metabolism. We will get insight into the importance of DNA methylation through these studies.

Creatine biosynthesis has been postulated as a major effector of homocysteine concentration and, on the other hand, elevated plasma homocysteine increases the risk of atherosclerotic disease. Assuming that several health benefits of creatine supplementation have already been proposed, such as, the lowering of homocysteine levels, neuroprotection, cholesterol lowering and ischemic cardiovascular damage protection [4]. Then, the increasing recognition of patients with creatine deficiency syndromes and the use of creatine supplementation will certainly improve knowledge on creatine and permit an evaluation of its benefits and risks.

Hyperornithinaemia patients were used as models for studying inhibition of GAA synthesis. How would the hyperornithinaemia patients fallout in the uric acid to creatinine assay? This would be another interesting point for further research.

Future research will hopefully answer the questions raised in this chapter. Actually, one of our aims for the near future is to throw some more light on several issues and prosecute with initiated studies. However, we admit that this study has just contributed as a minute piece to the completion of the million-piece puzzle of inborn errors of metabolism.

3. REFERENCES

- [1] Duran M, Dorland L, Meuleman EEE, Allers P, Berger R (1997) Inherited defects of purine and pyrimidine metabolism: Laboratory methods for diagnosis. *J Inher Metab Dis* **20**: 227-36.

- [2] Simmonds HA, Duley JA, Fairbanks LD, McBride MB (1997) When to investigate for purine and pyrimidine disorders. Introduction and review of clinical and laboratory indications. *J Inher Metab Dis* **20**: 214-226.

- [3] Verhoeven NM, Guérand WS, Struys EA, Bouman AA, Van der Knaap MS, Jakobs C (2000) Plasma creatinine assessment in creatine deficiency: A diagnostic pitfall. *J Inherit Metab Dis* **23**: 835-840.

- [4] Wyss M, Schulze A (2002) Health implications of creatine: can oral creatine supplementation protect against neurological and atherosclerotic disease? *Neuroscience* **112**(2): 243-260.

- [5] Schulze A (2003) Creatine deficiency syndromes. *Mol Cell Biochem* **244**: 143-150.

- [6] Schulze A, Ebinger F, Rating D, Mayatepek E (2001) Improving treatment of guanidinoacetate methyltransferase deficiency: reduction of guanidinoacetic acid in body fluids by arginine restriction and ornithine supplementation. *Mol Genet Metab* **74**(4): 413-19.

AKNOWLEDGEMENTS

AGRADECIMENTOS

AKNOWLEDGEMENTS / AGRADECIMENTOS

Os estudos que compõem esta tese devem-se a uma grande colaboração de pessoas e instituições. Gostaria de deixar aqui um reconhecimento especial a todos aqueles que tornaram possível a realização deste trabalho.

Nas breves linhas que se seguem agradeço àqueles que estiveram mais directamente envolvidos.

Gostaria, em primeiro lugar, de manifestar a minha especial gratidão aos responsáveis pela orientação desta tese.

Agradeço muito especialmente à Professora Doutora Isabel Tavares de Almeida por ter-me encaminhado, desde o início, nestes estudos e pela oportunidade que me concedeu de trabalhar com a sua equipa na fascinante área dos Erros Hereditários do Metabolismo. Agradeço todo o apoio e orientação que me proporcionou, os ensinamentos e o espírito de rigor que me transmitiu contribuindo para melhorar sempre o meu trabalho. A amizade e carinho com que sempre me recebeu no Centro de Patogénese Molecular fazendo com que me sentisse sempre “em casa” nas várias estadias em Lisboa. Foi tão bom voltar à querida família da Faculdade de Farmácia, rever colegas, Professores e funcionários. Muito obrigada por ter-me proporcionado esta oportunidade!

I gratefully acknowledge Doctor Marinus Duran for the enormous contribution to these studies. Ries, I don't know how to thank all your dedication and support. There are not enough words to express my deep gratitude! It was marvellous to work with you, to learn so many things from a big scientist like you. I feel so honoured and grateful for the opportunity of having a promotor like you. Thank you also for welcoming me at the AMC and for giving me the opportunity of working in your lab and meeting such nice personnel. I really appreciated your hospitality in Holland and also your trips to Madeira for our meetings. I am extremely grateful to you!

À Helena Tomás quero agradecer a amizade e todo o apoio que recebi ao longo destes anos. Enquanto responsável pelo Departamento, agradeço a

Aknowledgements

compreensão que permitiu a minha dispensa do serviço docente. Helena, agradeço a confiança que sempre depositaste no meu trabalho, o permanente incentivo, as palavras de conforto e constante disponibilidade para ouvir os meus desabafos. Obrigada por levatares a minha auto-estima sempre que esta estava por baixo!

I would like to express my gratitude to Prof. Dr. Ronald Wanders for welcoming me at the AMC. To Wilma Smit from the Laboratory of Genetic Metabolic Diseases, AMC, I would like to thank for her precious help in the lab during my stay and for her contribution to this work. Also to Susan Gersen for her help not only in the preparation of the manuscripts but also in finding some of the references.

I would also like to express my gratitude to Nanda Verhoeven, Gajja Salomons and Prof. Doctor Cornelis Jakobs from the VU University Medical Center, for the nice collaboration in this work.

Às minhas colegas da FFUL, Fátima, Rita, Margarida, Paula e Isabel agradeço imenso todo o apoio e amizade sempre manifestado nas minhas estadias no CPM. A vossa ajuda foi preciosa! Foi tão bom saber que podia sempre contar convosco!

Fátima, tu serás sempre uma amiga muito especial do outro lado do oceano, com quem pude sempre contar. Se não fosses tu... provavelmente não teria iniciado este trabalho! Obrigada por teres estabelecido o meu primeiro contacto com a Prof^l Isabel.

Rita e Margarida, obrigada pela permanente disponibilidade para me ajudar. Foi tão bom podermos trocar e-mails com frequência. Espero que possamos continuar em contacto!

As minhas palavras vão agora para as minhas amigas da UMa, com as quais partilhei muitos momentos, alguns bons... Para uma amiga muito especial, a Helena Figueira da Silva, a quem devo uma parte deste trabalho, um reconhecimento também especial. Obrigada por toda a tua ajuda, foi tão bom ter companhia no laboratório, ter alguém com quem conversar e tirar

Aknowledgements

impressões nos longos dias de trabalho entre plasmas e urinas. Saber que tinha uma farmacêutica com quem podia contar sempre que precisava de ajuda. Agradeço-te do fundo do coração!

Para a Cristina, minha grande amiga e companheira de gabinete. Foi tão bom poder contar contigo, desabafar e confidenciar. Não imagino como será não estares na secretária ao lado! Obrigada por todo o apoio psicológico e não só, pela permanente ajuda no sentido de deixar-me tempo livre para a tese.

À Isabel Torres e Zé Câmara com quem partilhei muitos momentos no laboratório, um especial obrigada pela ajuda que me proporcionaram e pelo incentivo que sempre me manifestaram ao longo deste trabalho.

Aos restantes colegas César, Fernanda (que pena já não estares connosco!), João Rodrigues, Paula Castilho. Obrigada pelo permanente apoio e companheirismo, pelas trocas de ideias e sugestões. Ao César agradeço também muito especialmente pela ajuda na elaboração desta capa.

Ao Zé Carlos Marques um especial reconhecimento pelo apoio na minha iniciação à cromatografia.

À aluna Lúcia Nascimento, pelo apoio no trabalho de laboratório.

Aos colegas da Secção Autónoma de Educação Física e Desporto, Rui Ornelas e à sua equipa do Projecto SAFEJ queria mostrar a minha gratidão pela colaboração neste trabalho. Agradeço todo o apoio e a permanente disponibilidade do Rui e dos seus colaboradores, especialmente o Odílio e a Marta.

Ao Eng^o Gonçalo Teixeira, do Sector de Informática, pelo apoio na formatação deste trabalho.

Às Irmãs do Centro Pedagógico da Sagrada Família queria deixar uma palavra de especial reconhecimento. À Directora do Centro, Irmã Lúcia, pela disponibilidade demonstrada; à Irmã Gorete Milho e à Irmã Adelaide pela excepcional dedicação e colaboração no estudo dos doentes. Aos médicos, Dr. Saturnino Silva e Dr. Rui Vasconcelos pelo interesse neste projecto e pela sua colaboração.

Aknowledgements

Por fim, queria manifestar a minha gratidão às pessoas mais importantes da minha vida, a quem esta tese também pertence:

À minha família, especialmente à minha irmã pelo apoio e compreensão. Aos meus cunhados pela amizade, espírito de entre-ajuda e solidariedade.

Gostaria de agradecer com especial carinho aos meus sogros. À minha sogra pela sua amizade, por todos os seus preciosos conselhos e ensinamentos que muito me têm ajudado e pela correcção do inglês desta tese. Ao meu sogro pela permanente disponibilidade para ajudar, que lhe é própria e também pela sua amizade.

Aos meus pais a quem devo um eterno e muito especial agradecimento. Obrigada por terem feito sempre tudo para que o meu mundo fosse o melhor e por estarem sempre a meu lado. Obrigada pelo estímulo, disponibilidade e pelo permanente apoio sem o qual este trabalho não teria sido possível. Esta tese é Vossa!

Agradeço muito especialmente e dedico este trabalho ao meu marido e grande amigo Francisco e às nossas filhas Inês e Leonor.

Chico, obrigada pelo apoio, estímulo e compreensão ao longo destes anos. Obrigada por estares sempre do meu lado e pelos sacrifícios feitos para que eu chegasse ao fim deste trabalho. Foi tão bom ter a tua companhia, poder contar contigo...!

À Inês em particular, pois foi por ela que enveredei pela área dos Erros Hereditários do Metabolismo...

CURRICULUM VITAE

CURRICULUM VITAE

Helena Paula de Freitas Caldeira Araújo was born in Funchal, Madeira Island, Portugal, on the 9th of November 1965. She attended High School in Funchal and applied to the Faculty of Pharmacy, University of Lisbon, in 1984. The graduation in Pharmaceutical Sciences, option Chemical and Biological Analysis was obtained in 1991.

In October 1991, she was admitted as a Junior Teaching Assistant at the Department of Chemistry, University of Madeira.

Her scientific activity was initiated in 1992 with the integration in a research project led by Prof. Dr. João Rodilhes Fraústo da Silva from the “*Instituto Superior Técnico*” (IST), Technical University of Lisbon and Prof. Dr. Madalena Humanes from the Faculty of Sciences, University of Lisbon. The work-plan was focused on “New vanadium insulin-mimetic compounds”. Several research stages, supported by scholarships awarded by CITMA, were undertaken at the IST under the supervision of Prof. Dr. José Armando Silva.

In September 1995, the “*Provas de Aptidão Pedagógica e Capacidade Científica*” (Pedagogic and Scientific Examination) were presented at the University of Madeira and the highest mark was obtained.

The PhD studies started with the project “Purines, creatine, defective methylation and their biochemical and clinical relationship” under the co-supervision of Dr. M. Duran from the Academic Medical Centre, University of Amsterdam, Prof. Dr. Isabel Tavares de Almeida from the Faculty of Pharmacy, University of Lisbon and Prof. Dr. Helena Tomás from the Department of Chemistry, University of Madeira. Supported by a PhD scholarship awarded by PRODEP in 1998, several stages were undertaken at the “*Centro de Patogénese Molecular*”, University of Lisbon, and at the Academic Medical Centre, University of Amsterdam.

At present and since 1995, she is a Teaching Assistant in the Department of Chemistry, University of Madeira, lecturing Analytical Chemistry.

LIST OF PUBLICATIONS DERIVED FROM THIS THESIS

Submitted papers

- [1] Caldeira Araújo H, Tomás H, Silva S, Vasconcelos R, Smit W, Tavares de Almeida I, Duran M. Urinary uric acid / creatinine ratio as a screening tool for creatine biosynthesis defects. Submitted for publication in *Ann Clin Biochem*.

- [2] Caldeira Araújo H, Smit W, Verhoeven NM, Salomons G, Silva S, Vasconcelos R, Tomás H, Tavares de Almeida I, Jakobs C, Duran M. Guanidinoacetate methyltransferase deficiency identified in mentally retarded adults. Submitted for publication in *Am J Med Genet*.

- [3] Caldeira Araújo H, Silva H, Ornelas R, Tomás H, Tavares de Almeida I, Duran M. Uric acid and creatinine levels in two groups of school children. Submitted for publication in *Ped Nephrol*.

- [4] Caldeira Araújo H, Silva H, Tomás H, Tavares de Almeida I, Duran M. A new solid-phase extraction procedure for purine and pyrimidine analysis. Submitted for publication in *J Chromat B*.

- [5] Caldeira Araújo, Smit W, Poll-The BT, Bakker HD, Duran M. Guanidinoacetic acid is decreased in hyperornithinemia. Submitted for publication in *J Inher Metab Dis*.

Posters and oral presentations

- [1] Caldeira Araújo H, Tomás H, Tavares de Almeida I. Análise de Purinas e Pirimidinas: Desenvolvimento de um Método por Cromatografia Líquida-Líquida de Alta Resolução em Fase Reversa. Oral presentation

List of publications

at *XIV Encontro Luso-Galego de Química*, November 2000, Braga, Portugal.

- [2] Caldeira Araújo H, Tomás H, Duran M, Tavares de Almeida I. Uric acid and creatinine levels in two groups of school children. Poster presented at *39th Annual Symposium of the Society for the Study of Inborn Errors of Metabolism - SSIEM*, September 2001, Prague, Czech Republic.
- [3] Caldeira Araújo H, Silva H, Tomás H, Duran M, Tavares de Almeida I. A new solid-phase extraction method for purines and pyrimidines' purification. Poster presented at *40th Annual Symposium of the Society for the Study of Inborn Errors of Metabolism - SSIEM*, September 2002, Dublin, Ireland.
- [4] Caldeira Araújo H, Smit W, Verhoeven NM, Tomás H, Silva S, Vasconcelos R, Tavares de Almeida I, Jakobs C, Duran M. Urinary uric acid vs creatinine as a screening tool for GAMT-deficiency. Poster presented at *40th Annual Symposium of the Society for the Study of Inborn Errors of Metabolism - SSIEM*, September 2002, Dublin, Ireland.
- [5] Caldeira Araújo H, Smit W, Verhoeven NM, Tomás H, Silva S, Vasconcelos R, Tavares de Almeida I, Jakobs C, Duran M. Guanidinoacetate methyltransferase (GAMT) deficiency a rare neurometabolic disorder: two new cases. Poster presented at *XIII Congresso Nacional de Bioquímica, Sociedade Portuguesa de Bioquímica (SPB)*, December 2002, Lisbon, Portugal.

